

PRICE LIST 2026

FURNITURE

US DOLLARS / EXCL. ALL TAXES / 01.2026

FRITZ HANSEN

CONTENT

03 • GENERAL TERMS AND CONDITIONS

CHAIRS

- 05 • Ant™
- 06 • Series 7™
- 07 • Series 7™
- 08 • Series 7™
- 09 • Grand Prix™
- 10 • Grand Prix™
- 11 • Grand Prix™
- 12 • Recrafted
- 13 • Lily™
- 14 • Drop™
- 15 • Little Giraffe™
- 16 • Oxford™
- 17 • Oxford™
- 18 • N02™ Recycle
- 19 • Vico Duo™
- 20 • Vico Duo™
- 21 • China Chair™
- 22 • Carimate™
- 23 • Monolit™
- 24 • After
- 25 • Director's Chair
- 26 • Hven
- 27 • Vester

LOUNGE

- 28 • Series 3300™
- 29 • Egg™
- 30 • Swan™
- 31 • Oksen™
- 32 • Pot™
- 33 • Lissoni Sofa™
- 34 • Ro™
- 35 • Fri™
- 36 • VIA57™
- 37 • Fred™
- 38 • Let™
- 39 • Monolit™

SOFAS

- 40 • Series 3300™
- 41 • Swan Sofa™
- 42 • Lissoni Sofa™
- 43 • Lissoni Sofa™
- 44 • Alphabet™ Sofa Series
- 45 • Alphabet™ Sofa Series
- 46 • Ro™ Sofa
- 47 • Fri™ Sofa
- 48 • Plenum™
- 49 • Plenum™

TABLES

- 50 • Superellipse™
- 51 • Superellipse™
- 52 • Supercircular™
- 53 • Circular
- 54 • Rectangular
- 55 • Egg™ Table
- 56 • FH3605™
- 57 • Essay™
- 58 • Essay™
- 59 • Analog™
- 60 • Pluralis™
- 61 • Pluralis™
- 62 • Pluralis™
- 63 • Pluralis™
- 64 • After
- 65 • Georg
- 66 • Georg
- 67 • Hven

SHELVING

- 68 • Planner™ Shelving
- 69 • Jut

SPARE PARTS

- 70 • Spare Parts
- 71 • Spare Parts

SURFACE SELECTION

- 72 • Surface Selection

GENERAL TERMS AND CONDITIONS

CURRENCY & EFFECTIVE DATE

This price list is valid from 1 January 2026 and cancels all prior price lists.

Reservation is made for any errors and omissions. Furthermore, below general terms and conditions shall apply to all contracts under which Fritz Hansen A/S (Fritz Hansen) is the supplier/ sub-supplier.

ORDERING

Orders must be placed through Fritz Hansen's web-based order system called the Partner Portal (www.fritzhansen.com - professional). Orders are not binding until the customer has received a written order confirmation from Fritz Hansen.

Price lists state the recommended retail price (RRP) or prices excl. VAT exclusive of freight and fees. All prices can be changed without notice. Changes to the collection such as discontinued products and/or items out of stock can occur even when stated differently in the price list. Updated information will be available on the partner portal only.

ORDER CANCELLATION

Orders can be cancelled in accordance with the below rules:

STOCK ITEMS (Outdoor, Lighting, Accessories & Small Furniture):

	ORDERS CANCELLED WITHIN 24 HOURS AFTER ORDER CONFIRMATION HAS BEEN SENT
STANDARD PRODUCTS	FEE: NONE
SPECIALS OR MODIFIED PRODUCTS	FEE: FULL PRICE

Change and cancellation of order after 24 hours from receipt of the order confirmation is not possible.

MTO (Furniture):

	ORDERS CANCELLED 0-3 DAYS AFTER ORDER CONFIRMATION HAS BEEN SENT	ORDERS CANCELLED 3-14 DAYS AFTER ORDER CONFIRMATION HAS BEEN SENT
STANDARD PRODUCTS	FEE: NONE	FEE: 5% OF NET PRICE EXCL. VAT.
SPECIALS OR MODIFIED PRODUCTS	FEE: FULL PRICE	

Change and cancellation of order after 14 days from receipt of the order confirmation is not possible.

DELIVERY

The following freight rates apply:

RATE	PER ORDER
EU+UK+NO+CH+US*	DKK 200 / € 55 / £ 50 / SEK 600 / NOK 550 / USD 55 EXCL. VAT.
REST OF THE WORLD	TO BE PICKED UP AT FRITZ HANSEN WAREHOUSES

For markets EU+UK+NO+CH+US free freight offered according to the following rates: Free shipping from DKK 3.000 / € 400 / £ 350 / SEK 4.500 / NOK 4.000 / USD 500 total order value excl. VAT.

* For deliveries to outer areas such as islands in Portugal and Spain as well as Svalbard in Norway and others, a surcharge of DKK 420 / € 56 / £ 42 / NOK 580 per parcel will apply.

Standard delivery terms:

- Denmark: DDP delivery address (INCO-Terms 2020)
- Countries within the EU: DDP delivery address (INCO-Terms 2020)
- European countries outside the EU: DAP delivery address (INCO-Terms 2020)
- USA: DDP delivery address (INCO-Terms 2020)
- Canada:
 - Contract customers: DAP delivery address (INCO-Terms 2020)
 - Retail customers: DAT Montreal Terminal, EXW Horsens, DK
- Japan: DDP delivery address (INCO-Terms 2020)
- South Korea: DDP Fritz Hansen Busan (INCO-Terms 2020)
- Middle East, Asia, South and Central America, Australia: FCA Fritz Hansen warehouses in Denmark (INCO-Terms 2020)

Special address deliveries:

- Delivery to non-standard warehouse with truck access and unloading ramp.
- Customer/Partner must confirm requirements are met.

Fee: DKK 1.100/€ 150/£ 130/SEK 1.600/NOK 1.700/USD 175 excl. VAT.

White glove / Special deliveries:

- Direct delivery where export truck cannot access (lift or small truck required).

Fee: Case-by-case via Fritz Hansen's shipping department.

Fix deliveries:

- Delivery on a fixed day to warehouse address.

Fee: DKK 1.100/€ 150/£ 130/SEK 1.600/NOK 1.700/USD 175 excl. VAT.

For FCA: The goods must be picked up at the Fritz Hansen warehouses no later than 30 calendar days after the confirmed shipping date of the consolidated order. Address(es) for pickup will be specified on the commercial invoice. If the goods are not picked up, Fritz Hansen will charge the customer DKK 24 / € 3 / USD 4 per day per colli (all furniture orders are colli based) or pallet (all Lighting, Accessories, and Skagerak Collection orders are pallet based).

CLAIMS

The physical product must be inspected upon delivery. Damage incurred in transit as well as any defects and deficiencies on the product incurred as a result of transportation must be recorded on the POD upon delivery. Fritz Hansen must be notified in writing of any claims about product defects and deficiencies within 48 hours of delivery. If the claims are made in due time and with the acceptance of Fritz Hansen, the customer is entitled to demand a replacement delivery or to have the defect remedied. The customer cannot demand a reduction or a compensation. Claims/Replacements can only be made to the customer's address if delivery has not been made directly to the end user.

MEASUREMENTS

The stated measurements act only as a guideline. The measurements can vary, and size difference on a product can occur.

TERMS OF PAYMENT

Terms of payment are 30 days net cash from invoice date. Invoices are issued and dated when the goods are dispatched. In case of late payment, interest will be charged at a rate of 1.5 % for every month or part thereof as from the due date. Interest invoices are payable net cash within eight days. Fritz Hansen can decide that the customer shall pay in advance, if the customer's balance is or has previously been due, or if the order amount exceeds the credit limit approved by Fritz Hansen.

OBSERVATION OF TITLE

Title to the goods shall not pass to the customer until Fritz Hansen (or any third party to whom Fritz Hansen has assigned its rights to the purchase price) has received the full purchase price and been reimbursed any expenses incurred.

LIMITATION OF LIABILITY

Fritz Hansen will assume no liability for any loss as a result of delays, defects or any other breach of contract, unless such loss was caused by gross negligence on the part of Fritz Hansen. Fritz Hansen will assume no liability for any indirect loss, including loss of profits, operating loss, goodwill, loss of customers, running costs or any other consequential economic loss.

CHOICE OF LAW AND JURISDICTION

Disputes between Fritz Hansen and its customers shall be subject to Danish law and shall be settled by Fritz Hansen's home court.

FORCE MAJURE

Fritz Hansen is without liability for non-performance of Fritz Hansen's obligations in respect to any orders received, if such non-performance is due to circumstances out of Fritz Hansen's reasonable control, which prevent the fulfilment of the purchase agreement or makes the fulfilment unreasonably burdensome. As examples of such circumstances the following can be mentioned: Industrial dispute and other circumstances which are beyond the control of the parties, such as fire, war, mobilization or calling in for military service of similar extent, requisition, seizure, exchange controls, riots or disturbances, shortage of means of transportation, ordinary scarcity of goods, restrictions of motive power and defects in or late performance from sub-suppliers due to any of the aforementioned circumstances.

The above circumstances only lead to exemption from liability if their influence on the fulfilment of the purchase agreement could not be anticipated at the conclusion of the agreement. Fritz Hansen must without undue delay notify the customer in writing if any such circumstances, occurrence and cessation, if Fritz Hansen wishes to invoke any grounds of exemption from liability.

Regardless of what follows from these general conditions of sales and delivery, any party is entitled to terminate the purchase agreement by notifying the other party in writing, if the fulfilment of the agreement is prevented for more than 6 months due to one of the above circumstances.

Unless mandatory rules preclude this, Fritz Hansen is in no case liable to the customer for operating losses, lost earnings, or other financial consequential damages under these general conditions for sale and delivery.

PRIVACY POLICY

At Fritz Hansen, confidentiality and data protection is a high priority. Guidelines for processing of personal data and description of the customer's and end users' rights according to applicable data protection law is governed by Fritz Hansen's privacy policy available on Fritz Hansen's website.

WARRANTY

Fritz Hansen provides warranty on standard products against defects in materials and workmanship.

Furniture and Outdoor: The standard warranty is 5 years. For the Arne Jacobsen shell chairs (Ant™, Grand Prix™, Lily™, Series 7™), the standard warranty is 10 years. The China Chair™ has a standard warranty of 20 years. Within the Furniture collection, an extended warranty of up to 10 years is provided on selected products (see table below for details).

Poul Kjærholm: The standard warranty is 20 years except for PK0 A™, PK60™ and PK111™, which is 10 years, and PK3™, PK15™ and PK23™, which is 5 years. Wicker and French Cane have a warranty of 2 years.

Lighting and Accessories & Small Furniture: The standard warranty is 2 years. Within the Accessories & Small Furniture collection, an extended warranty of up to 5 years is provided on selected products. Specific for the Lighting collection: Transformers, ballasts, light sources, and other electronic devices are subject to the warranty terms of the manufacturer in question. Fritz Hansen does not cover costs related to installation and dismantling, replacement of ballasts/transformers and other similar costs related to electricians and the like.

The warranty on all collections does not extend to ordinary tear, wear or damage to upholstery. On any material, textile, or leather which is not listed in our price lists configured on a specific product, the standard warranty is 2 years. The warranty is void upon subsequent changes to the product. The warranty is valid from the date of delivery.

ReNEW: Refurbished chairs automatically come with a 10-year warranty from the date of delivery. All refurbished chairs are provided with a new label stating its originality and the year of refurbishment. Recrafted chairs automatically come with a 10-year warranty from the date of delivery.

Additional warranty conditions can be found on www.fritzhansen.com.

RIGHT OF RETENTION

All items received by Fritz Hansen for repair, reupholstery, and/or processing remain the property of their legal owner, whether this is the Customer/Partner or the end customer. Fritz Hansen does not acquire ownership but is entitled to retain the items until full payment has been received for all work performed, materials supplied, and expenses incurred. This right of retention also applies in the event of the Customer/Partner's or the end customer's bankruptcy, reconstruction, liquidation, or any other inability to meet payment obligations and may be exercised against third parties, provided that the items were received with the consent of the owner or their authorised representative.

WARRANTY OVERVIEW

Price list collections	Furniture collection						Poul Kjærholm collection				Outdoor collection	Lighting collection	Accessories & Small Furniture collection					
	Textile, Cushions	Leather (1)	Leather (2)	Bases (3)	Bases (4)	Movable parts (5)	Ant™, Grand Prix™, Lily™, Series 7™	ReNEW: Refurbish, Recrafted	Shells, Tabletops	Tabletops (6)	China Chair™	French Cane, Wicker	PK3™, PK15™, PK23™	PK0 A™, PK60™, PK111™	Poul Kjærholm Collection	Outdoor	Lighting	Accessories
2 years											x					x		
5 years	x	x		x		x			x			x			x			x*
10 years			x*		x*		x	x	x*				x					
20 years										x				x				

1. Leather: Soft and Essential
2. Leather: Aura, Haze, Natural, Grace and Embrace
3. Bases: Lacquered and Wooden (chairs), Powder coated (chairs and tables)
4. Bases: Aluminium, Chrome and Wooden (tables)
5. Moveable parts: Automatic return, Tilt, Height-adjustable, Swivel, Castors and Extension mechanism
6. Tabletops: Lacquer under tabletop, Lacquer on edges and Surface on tabletop

*Find detailed overview on www.fritzhansen.com/warranty



ANT™
ARNE JACOBSEN 1952

01.2026

The Ant™ comes in clear lacquered, colored ash or lacquered veneer. All chairs are made of pressure molded veneer and are stackable. The shell is also available in front upholstered versions in a wide range of textiles and leather types. The base comes with 3 or 4 legs made of chromed or powdercoated tubular steel.

MODEL	DESCRIPTION	COLOURED VENEER	LACQUERED VENEER	CLEAR LACQUERED VENEER
3100	Chair, 3 legs, stackable (max 8 pcs), seat height 17.3" or 18.1", chromed or powder coated tubular steel base	479	519	719
3101	Chair, 4 legs, stackable (max 12 pcs), seat height 16.9" or 18.1", chromed or powder coated tubular steel base	479	519	719

COLORED/LACQUERED VENEER - SEE THE SURFACE SELECTION
PALE ROSE (615/610), WILD ROSE (635/630), VENETIAN RED (675/670), PARADISE ORANGE (575/570), BURNT YELLOW (475/470), TRUE YELLOW (465/460), LIGHT BEIGE (135/130), DEEP CLAY (145/140), OLIVE GREEN (925/920), LAVENDER BLUE (815/810), DUSK BLUE (855/850), MIDNIGHT BLUE (895/890), EVERGREEN (955/950), BLACK (195/190), NINE GREY (155/150), WHITE (105/100)

CLEAR LACQUERED VENEER: - SEE THE SURFACE SELECTION
BEECH, CHERRY, ELM, OAK, WALNUT, OAK - DARK STAINED

BASE COLORS
SILVER GREY, WARM GRAPHITE, BROWN BRONZE, BLACK, WHITE (ONLY WITH WHITE SHELL), CHROME

FRONT UPHOLSTERED - COLORED ASH VENEER

MODEL	DESCRIPTION	CHRISTIANSHAVN	CATEGORY 1	CATEGORY 2	CATEGORY 3	CATEGORY 4	CATEGORY 5
3100	Chair, 3 legs, seat height 17.3" or 18.1", chromed or powder coated tubular steel base	729	819	869	1,199	1,449	1,899
3101	Chair, 4 legs, seat height 16.9" or 18.1", chromed or powder coated tubular steel base	729	819	869	1,199	1,449	1,899

FRONT UPHOLSTERED - LACQUERED VENEER

MODEL	DESCRIPTION	CHRISTIANSHAVN	CATEGORY 1	CATEGORY 2	CATEGORY 3	CATEGORY 4	CATEGORY 5
3100	Chair, 3 legs, seat height 17.3" or 18.1", chromed or powder coated tubular steel base	759	829	889	1,199	1,449	1,949
3101	Chair, 4 legs, seat height 16.9" or 18.1", chromed or powder coated tubular steel base	759	829	889	1,199	1,449	1,949

FRONT UPHOLSTERED - CLEAR LACQUERED VENEER

MODEL	DESCRIPTION	CHRISTIANSHAVN	CATEGORY 1	CATEGORY 2	CATEGORY 3	CATEGORY 4	CATEGORY 5
3100	Chair, 3 legs, seat height 17.3" or 18.1", chromed or powder coated tubular steel base	979	1,049	1,099	1,449	1,699	2,199
3101	Chair, 4 legs, seat height 16.9" or 18.1", chromed or powder coated tubular steel base	979	1,049	1,099	1,449	1,699	2,199

CATEGORY 1: Canvas, Capture, Fame, Remix, Re-Wool, Technicolor, Tonus
CATEGORY 2: Acca, Cifrado, Clay, Fiord, Hallingdal, Karakorum, Moss, Steelcut, Steelcut Trio, Sunniva, Vanir, Vidar
CATEGORY 3: Essential, Fuse, Mammuth, Voulez-Vous
CATEGORY 4: Haze, Soft
CATEGORY 5: Grace, Natural

SELECTED TEXTILE COLORS - SEE THE SURFACE SELECTION
VANIR (193, 243, 373,393, 413, 443, 473, 693, 733, 773, 913, 983)

DESCRIPTION	PRICE
Linking device for 3101	119
Felt glides (3 or 4 pcs.) – added cost to chair price. See Spare Parts section for prices of extra felt glides	14
Small transport dolly for 8 chairs (3100) or 12 chairs (3101)	679
Large transport dolly for 40 chairs	1,299
Chair rack, mounted under a table top	99

3100 3101 SMALL AND LARGE TRANSPORT DOLLY FOR STACKABLE CHAIRS

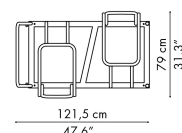
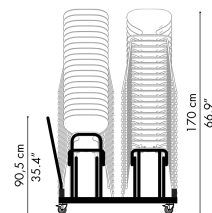
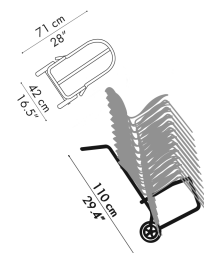
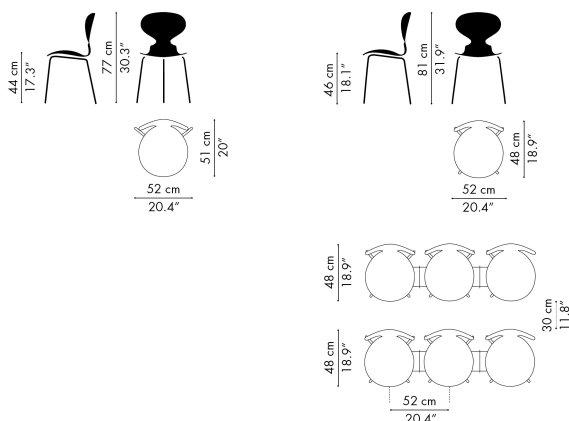



SERIES 7™
ARNE JACOBSEN 1955

01.2026

The Series 7™ chair comes in three different finishes: Clear lacquered, colored ash or lacquered veneer. All chairs are made of pressure molded veneer. The shell is also available in front or fully upholstered versions in a wide range of textiles and leather types. Besides a base with four legs made of tubular steel, it also comes with a height-adjustable swivel base and castors, a counter or a bar stool. The bases of the Series 7™ are available with either a chromed or powder coated finish.

MODEL	DESCRIPTION	COLOURED VENEER	LACQUERED VENEER	CLEAR LACQUERED VENEER
3107	Chair, stackable (max 12 pcs.), seat height 16.9" or 18.1", chromed or powder coated tubular steel base	669	699	789
3207	Armchair, seat height 16.9" or 18.1", chromed or powder coated tubular steel base	1,149	1,299	1,399
3187	Counter stool, seat height 25.2", chromed or powder coated tubular steel base	959	989	1,099
3197	Bar stool, seat height 25.9", chromed or powder coated tubular steel base	959	989	1,099
3117	Swivel chair, adjustable seat height 17.3"-22", 5 castors, chromed or powder coated tubular steel base	1,499	1,599	1,649
3217	Swivel armchair, adjustable seat height 17.3"-22", 5 castors, chromed or powder coated tubular steel base	1,949	2,099	2,299

COLORED/LACQUERED VENEER - SEE THE SURFACE SELECTION
PALE ROSE (615/610), WILD ROSE (635/630), VENETIAN RED (675/670), PARADISE ORANGE (575/570), BURNT YELLOW (475/470), TRUE YELLOW (465/460), LIGHT BEIGE (135/130), DEEP CLAY (145/140), OLIVE GREEN (925/920), LAVENDER BLUE (815/810), DUSK BLUE (855/850), MIDNIGHT BLUE (895/890), EVERGREEN (955/950), BLACK (195/190), NINE GREY (155/150), WHITE (105/100)

CLEAR LACQUERED VENEER: - SEE THE SURFACE SELECTION
BEECH, CHERRY, ELM, OAK, WALNUT, OAK - DARK STAINED

BASE COLORS
SILVER GREY, WARM GRAPHITE, BROWN BRONZE, BLACK, WHITE (ONLY WITH WHITE SHELL & NOT AVAILABLE FOR MODELS WITH SWIVEL BASE ;3117 & 3217), CHROME

FRONT UPHOLSTERED - COLORED ASH VENEER

MODEL	DESCRIPTION	CHRISTIANSHAVN	CATEGORY 1	CATEGORY 2	CATEGORY 3	CATEGORY 4	CATEGORY 5
3107	Chair, seat height 16.9" or 18.1", chromed or powder coated tubular steel base	959	1,049	1,099	1,349	1,499	1,699
3207	Armchair, seat height 16.9" or 18.1", chromed or powder coated tubular steel base	1,449	1,499	1,549	1,599	1,799	1,999
3187	Counter stool, seat height 25.2", chromed or powder coated tubular steel base	1,249	1,349	1,399	1,599	1,799	1,999
3197	Bar stool, seat height 25.9", chromed or powder coated tubular steel base	1,249	1,349	1,399	1,599	1,799	1,999
3117	Swivel chair, adjustable seat height 17.3"-22", 5 castors, chromed or powder coated tubular steel base	1,799	1,899	1,949	2,199	2,299	2,499
3217	Swivel armchair, adjustable seat height 17.3"-22", 5 castors, chromed or powder coated tubular steel base	2,299	2,299	2,399	2,499	2,699	2,899

FRONT UPHOLSTERED - LACQUERED VENEER

MODEL	DESCRIPTION	CHRISTIANSHAVN	CATEGORY 1	CATEGORY 2	CATEGORY 3	CATEGORY 4	CATEGORY 5
3107	Chair, seat height 16.9" or 18.1", chromed or powder coated tubular steel base	979	1,049	1,099	1,349	1,499	1,699
3207	Armchair, seat height 16.9" or 18.1", chromed or powder coated tubular steel base	1,599	1,649	1,699	1,799	1,899	2,099
3187	Counter stool, seat height 25.2", chromed or powder coated tubular steel base	1,299	1,349	1,399	1,649	1,799	1,999
3197	Bar stool, seat height 25.9", chromed or powder coated tubular steel base	1,299	1,349	1,399	1,649	1,799	1,999
3117	Swivel chair, adjustable seat height 17.3"-22", 5 castors, chromed or powder coated tubular steel base	1,899	1,949	1,999	2,299	2,299	2,499
3217	Swivel armchair, adjustable seat height 17.3"-22", 5 castors, chromed or powder coated tubular steel base	2,399	2,499	2,599	2,599	2,899	3,099

FRONT UPHOLSTERED - CLEAR LACQUERED VENEER

MODEL	DESCRIPTION	CHRISTIANSHAVN	CATEGORY 1	CATEGORY 2	CATEGORY 3	CATEGORY 4	CATEGORY 5
3107	Chair, seat height 16.9" or 18.1", chromed or powder coated tubular steel base	1,099	1,199	1,249	1,499	1,649	1,899
3207	Armchair, seat height 16.9" or 18.1", chromed or powder coated tubular steel base	1,699	1,799	1,849	1,899	2,099	2,299
3187	Counter stool, seat height 25.2", chromed or powder coated tubular steel base	1,399	1,499	1,549	1,799	1,999	2,199
3197	Bar stool, seat height 25.9", chromed or powder coated tubular steel base	1,399	1,499	1,549	1,799	1,999	2,199
3117	Swivel chair, adjustable seat height 17.3"-22", 5 castors, chromed or powder coated tubular steel base	1,999	2,099	2,199	2,399	2,499	2,599
3217	Swivel armchair, adjustable seat height 17.3"-22", 5 castors, chromed or powder coated tubular steel base	2,599	2,599	2,699	2,799	2,999	3,199

CATEGORY 1: Belfast, Canvas, Capture, Fame, Remix, Re-Wool, Technicolor, Tonus
CATEGORY 2: Acca, Cifrado, Clay, Fiord, Hallingdal, Karakorum, Moss, Steelcut, Steelcut Trio, Sunniva, Vanir, Vidar
CATEGORY 3: Essential, Fuse, Mammuth, Voulez-Vous
CATEGORY 4: Haze, Soft
CATEGORY 5: Grace, Natural

SELECTED TEXTILE COLORS - SEE THE SURFACE SELECTION
BELFAST (770593, 770660, 771772, 772062, 772143, 772150, 772255, 774232, 774926, 775139)
VANIR (193, 243, 373,393, 413, 443, 473, 693, 733, 773, 913, 983)



FULLY UPHOLSTERED

MODEL	DESCRIPTION	CHRISTIANSHAVN	CATEGORY 1	CATEGORY 2	CATEGORY 3	CATEGORY 4	CATEGORY 5
3107	Chair, seat height 16.9" or 18.1", chromed or powder coated tubular steel base	1,099	1,149	1,249	1,599	1,699	1,999
3207	Armchair, seat height 16.9" or 18.1", chromed or powder coated tubular steel base	1,499	1,599	1,649	1,899	2,099	2,299
3187	Counter stool, seat height 25.2", chromed or powder coated tubular steel base	1,499	1,549	1,599	1,999	2,099	2,399
3197	Bar stool, seat height 25.9", chromed or powder coated tubular steel base	1,499	1,549	1,599	1,999	2,099	2,399
3117	Swivel chair, adjustable seat height 17.3"-22", 5 castors, chromed or powder coated tubular steel base	1,799	1,899	1,999	2,299	2,399	2,699
3217	Swivel armchair, adjustable seat height 17.3"-22", 5 castors, chromed or powder coated tubular steel base	2,349	2,499	2,599	2,799	2,999	3,199

CATEGORY 1: Belfast, Canvas, Capture, Fame, Remix, Re-Wool, Technicolor, Tonus
 CATEGORY 2: Acca, Cifrado, Clay, Fiord, Hallingdal, Karakorum, Moss, Steelcut, Steelcut Trio, Sunniva, Vanir, Vidar
 CATEGORY 3: Essential, Fuse, Mammuth, Voulez-Vous
 CATEGORY 4: Haze, Soft
 CATEGORY 5: Grace, Natural

SELECTED TEXTILE COLORS - SEE THE SURFACE SELECTION

OPTIONS

DESCRIPTION	PRICE
Hard castor for soft floors with or without brake	No surcharge
Soft castor for hard floors with or without brake	No surcharge
Linking device for 3107, short	119
Linking device for 3107 w/writing tablet and 3207, long	119
Writing tablet for 3107, coloured veneer: black, chromed arm (Other colors are made to order, MOQ: 25 pcs)	499
Small transport dolly for 12 pcs. 3107 chairs, non-upholstered	679
Large transport dolly for 40 pcs. 3107 chairs, non-upholstered	1,299
Felt glides (4 pcs.) – added cost to chair price. See Spare Parts section for prices of extra felt glides	14
Chair rack for 3107 chairs, mounted under a table top, for non-upholstered chairs only	99
3107SC Seat cushion, Wild leather, walnut (colli 4 pcs)	159
3107SC Seat cushion, Raw leather, black (colli 4 pcs)	119
3107SC Seat cushion, Intense leather, brown (colli 4 pcs.)	119



3107

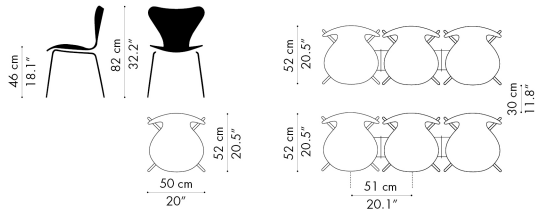

3107 WITH WRITING TABLET

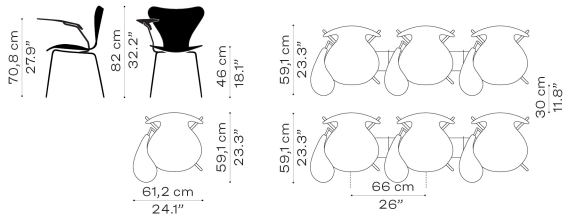

3207

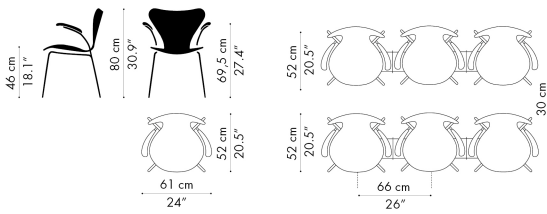

3117

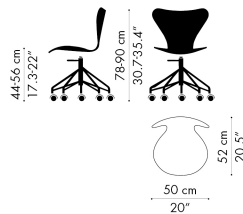

3217

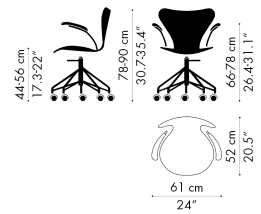

3187

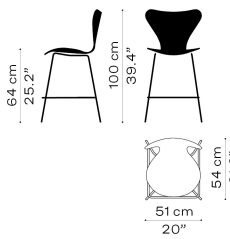

3197

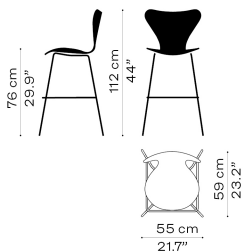

SMALL AND LARGE TRANSPORT DOLLY FOR STACKABLE CHAIRS

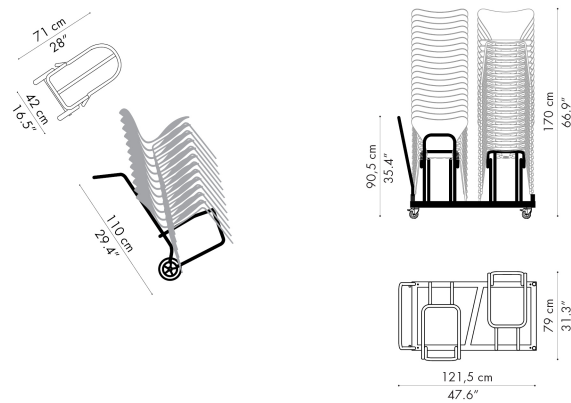



GRAND PRIX™
ARNE JACOBSEN 1957

01.2026

The Grand Prix™ comes in clear lacquered (oak or walnut), colored ash or lacquered (only 3130) veneer. All chairs are made of pressure molded veneer. Front upholstery or full upholstery is available in a wide range of fabrics and leather types. The base comes with four legs in several variants: Chromed or powder coated tubular steel (stackable max 5 pcs.) and wooden legs (non-stackable). Besides a base with four legs made of tubular steel, it also comes with a height-adjustable swivel base and castors, a counter or a bar stool.

MODEL	DESCRIPTION	COLOURED VENEER	LACQUERED VENEER	CLEAR LACQUERED VENEER
3130	Chair, stackable (max 5 pcs.) seat height 16.9" or 18.1", chromed or powder coated tubular steel base	679	699	789
4130	Chair, seat height 17.3" or 18.1", wooden legs	939		979
3138	Counter stool, seat height 25.2", chromed or powder coated tubular steel base	919	939	1,049
3139	Bar stool, seat height 25.9", chromed or powder coated tubular steel base	919	939	1,049
3131	Swivel chair, adjustable seat height 17.3"-22", 5 castors, chromed or powder coated tubular steel base	1,449	1,499	1,599

COLORED/LACQUERED VENEER - SEE THE SURFACE SELECTION
PALE ROSE (615/610), WILD ROSE (635/630), VENETIAN RED (675/670), PARADISE ORANGE (575/570), BURNT YELLOW (475/470), TRUE YELLOW (465/460), LIGHT BEIGE (135/130), DEEP CLAY (145/140), OLIVE GREEN (925/920), LAVENDER BLUE (815/810), DUSK BLUE (855/850), MIDNIGHT BLUE (895/890), EVERGREEN (955/950), BLACK (195/190), NINE GREY (155/150), WHITE (105/100)

CLEAR LACQUERED VENEER: - SEE THE SURFACE SELECTION
OAK, WALNUT

BASE COLORS
3130, 3131, 3138, 3139: SILVER GREY, WARM GRAPHITE, BROWN BRONZE, BLACK, WHITE (ONLY WITH WHITE SHELL & NOT AVAILABLE FOR MODELS WITH SWIVEL BASE; 3131), CHROME
4130*: OAK, WALNUT, BLACK, WHITE (ONLY WITH WHITE SHELL)

[*OAK/WALNUT VENEER SHELLS ARE ONLY AVAILABLE WITH MATCHING WOODEN BASE]

FRONT UPHOLSTERED - COLORED ASH VENEER

MODEL	DESCRIPTION	CHRISTIANSHAVN	CATEGORY 1	CATEGORY 2	CATEGORY 3	CATEGORY 4	CATEGORY 5
3130	Chair, stackable (max 5 pcs.) seat height 16.9" or 18.1", chromed or powder coated tubular steel base	959	1,049	1,099	1,349	1,499	1,699
4130	Chair, seat height 16.9" or 18.1", wooden legs	1,249	1,299	1,399	1,599	1,699	1,899
3138	Counter stool, seat height 25.2", chromed or powder coated tubular steel base	1,199	1,299	1,349	1,549	1,699	1,899
3139	Bar stool, seat height 25.9", chromed or powder coated tubular steel base	1,199	1,299	1,349	1,549	1,699	1,899
3131	Swivel chair, adjustable seat height 17.3"-22", 5 castors, chromed or powder coated tubular steel base	1,699	1,799	1,849	2,099	2,199	2,399

FRONT UPHOLSTERED - LACQUERED VENEER

MODEL	DESCRIPTION	CHRISTIANSHAVN	CATEGORY 1	CATEGORY 2	CATEGORY 3	CATEGORY 4	CATEGORY 5
3130	Chair, stackable (max 5 pcs.) seat height 16.9" or 18.1", chromed or powder coated tubular steel base	979	1,049	1,099	1,349	1,499	1,699
3138	Counter stool, seat height 25.2", chromed or powder coated tubular steel base	1,199	1,299	1,349	1,599	1,699	1,899
3139	Bar stool, seat height 25.9", chromed or powder coated tubular steel base	1,199	1,299	1,349	1,599	1,699	1,899
3131	Swivel chair, adjustable seat height 17.3"-22", 5 castors, chromed or powder coated tubular steel base	1,799	1,849	1,899	2,199	2,499	2,899

FRONT UPHOLSTERED - CLEAR LACQUERED VENEER

MODEL	DESCRIPTION	CHRISTIANSHAVN	CATEGORY 1	CATEGORY 2	CATEGORY 3	CATEGORY 4	CATEGORY 5
3130	Chair, stackable (max 5 pcs.) seat height 16.9" or 18.1", chromed or powder coated tubular steel base	1,099	1,199	1,249	1,499	1,649	1,899
4130	Chair, seat height 16.9" or 18.1", wooden legs	1,299	1,349	1,399	1,599	1,749	1,899
3138	Counter stool, seat height 25.2", chromed or powder coated tubular steel base	1,349	1,399	1,499	1,699	1,899	1,999
3139	Bar stool, seat height 25.9", chromed or powder coated tubular steel base	1,349	1,399	1,499	1,699	1,899	1,999
3131	Swivel chair, adjustable seat height 17.3"-22", 5 castors, chromed or powder coated tubular steel base	1,899	1,949	1,999	2,299	2,599	2,999

CATEGORY 1: Belfast, Canvas, Capture, Fame, Remix, Re-Wool, Technicolor, Tonus
CATEGORY 2: Acca, Cifrado, Clay, Fiord, Hallingdal, Karakorum, Moss, Steelcut, Steelcut Trio, Sunniva, Vanir, Vidar
CATEGORY 3: Essential, Fuse, Mammuth, Voulez-Vous
CATEGORY 4: Haze, Soft
CATEGORY 5: Grace, Natural

SELECTED TEXTILE COLORS - SEE THE SURFACE SELECTION
VANIR (193, 243, 373, 393, 413, 443, 473, 693, 733, 773, 913, 983)



FULLY UPHOLSTERED

MODEL	DESCRIPTION	CHRISTIANSHAVN	CATEGORY 1	CATEGORY 2	CATEGORY 3	CATEGORY 4	CATEGORY 5
3130	Chair, seat height 16.9" or 18.1", chromed or powder coated tubular steel base	1,099	1,149	1,249	1,599	1,699	1,999
4130	Chair, seat height 16.9" or 18.1", wooden legs	1,399	1,449	1,499	1,849	1,949	2,299
3138	Counter stool, seat height 25.2", chromed or powder coated tubular steel base	1,399	1,499	1,549	1,899	1,999	2,299
3139	Bar stool, seat height 25.9", chromed or powder coated tubular steel base	1,399	1,499	1,549	1,899	1,999	2,299
3131	Swivel chair, adjustable seat height 17.3"-22", 5 castors, chromed or powder coated tubular steel base	1,749	1,849	1,899	2,299	2,599	3,099

CATEGORY 1: Belfast, Canvas, Capture, Fame, Remix, Re-Wool, Technicolor, Tonus
 CATEGORY 2: Acca, Cifrado, Clay, Fiord, Hallingdal, Karakorum, Moss, Steelcut, Steelcut Trio, Sunniva, Vanir, Vidar
 CATEGORY 3: Essential, Fuse, Mammuth, Voulez-Vous
 CATEGORY 4: Haze, Soft
 CATEGORY 5: Grace, Natural

SELECTED TEXTILE COLORS - SEE THE SURFACE SELECTION
 VANIR (193, 243, 373,393, 413, 443, 473, 693, 733, 773, 913, 983)

OPTIONS

DESCRIPTION	PRICE
Hard castor for soft floors with or without brake	No surcharge
Soft castor for hard floors with or without brake	No surcharge
Linking device for 3130 chairs	119
Small transport dolly for 5 pcs. 3130 chairs, non-upholstered	679
Chair rack for 3130 chairs, mounted under a table top, for non-upholstered chairs only	99
Felt glides (4 pcs.) – added cost to chair price. See Spare Parts section for prices of extra felt glides	14



3130

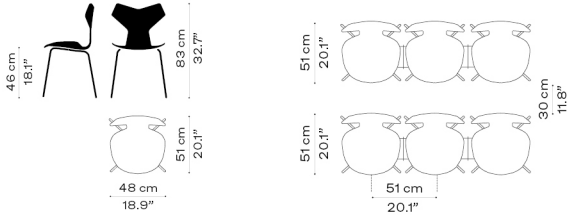

4130

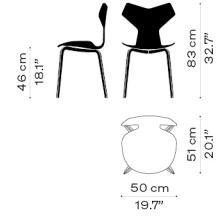

3131

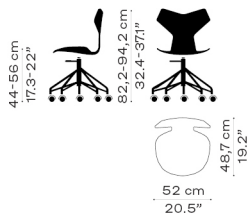

3138

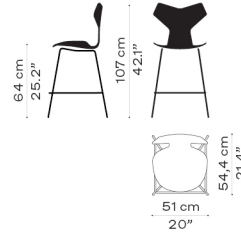

3139

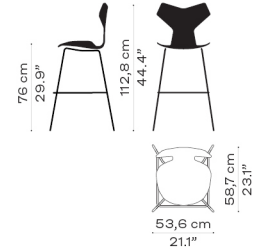

SMALL TRANSPORT DOLLY FOR STACKABLE CHAIRS

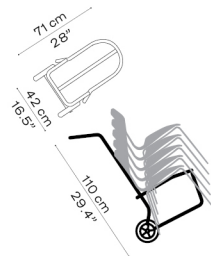



**RECRRAFTED
ARNE JACOBSEN**

01.2026

Fritz Hansen's certified recrafted service offers restored; original Arne Jacobsen shell chairs including ready to start their next life. Available models include the Ant™, Series 7™, and Grand Prix™. Chairs in the recrafted programme undergo a thorough refurbishment process. Each piece is carefully inspected to ensure it meets quality criteria before being offered for sale.

ANT™ RECRRAFTED - COLOURED & LACQUERED VENEER

MODEL	DESCRIPTION	COLOURED VENEER	LACQUERED VENEER
3101RC	Chair, 4 legs, stackable (max 12 pcs), seat height 16.9" or 18.1", chromed or powder coated tubular steel base	479	519

SERIES 7™ RECRRAFTED - COLOURED & LACQUERED VENEER

MODEL	DESCRIPTION	COLOURED VENEER	LACQUERED VENEER
3107RC	Chair, stackable (max 12 pcs.), seat height 16.9" or 18.1", chromed or powder coated tubular steel base	669	699

GRAND PRIX™ RECRRAFTED - COLOURED & LACQUERED VENEER

MODEL	DESCRIPTION	COLOURED VENEER	LACQUERED VENEER
3130RC	Chair, stackable (max 5 pcs.) seat height 16.9" or 18.1", chromed or powder coated tubular steel base	679	699

SERIES 7™ RECRRAFTED - FULLY UPHOLSTERED

MODEL	DESCRIPTION	CHRISTIANSHAVN	CATEGORY 2	CATEGORY 3
3107FUR	Chair, seat height 16.9" or 18.1", chromed or powder coated tubular steel base	1,099	1,249	1,599

CATEGORY 2: Hallingdal
CATEGORY 3: Essential

GRAND PRIX™ RECRRAFTED - FULLY UPHOLSTERED

MODEL	DESCRIPTION	CHRISTIANSHAVN	CATEGORY 2	CATEGORY 3
3130FUR	Chair, seat height 16.9" or 18.1", chromed or powder coated tubular steel base	1,099	1,249	1,599

CATEGORY 2: Hallingdal
CATEGORY 3: Essential



The Lily™ chair comes in 2 variants; with or without arms, in clear lacquered walnut veneer or fully upholstered in a wide range of textiles and leather types. All chairs are made of pressure molded veneer. The base comes with 4 legs made of chromed tubular steel.

MODEL	DESCRIPTION	CLEAR LACQUERED WALNUT
3108	Chair, stackable, seat height 16.9" or 18.1", chromed tubular steel base	879
3208	Armchair, seat height 16.9" or 18.1", chromed tubular steel base	1,499

FULLY UPHOLSTERED

MODEL	DESCRIPTION	CHRISTIANSHAVN	CATEGORY 1	CATEGORY 2	CATEGORY 3	CATEGORY 4	CATEGORY 5
3108	Chair, seat height 16.9" or 18.1", chromed tubular steel base	1,299	1,399	1,499	1,699	1,899	2,099
3208	Armchair, seat height 16.9" or 18.1", chromed tubular steel base	2,099	2,199	2,299	2,499	4,499	2,899

CATEGORY 1: Canvas, Capture, Fame, Remix, Re-Wool, Technicolor, Tonus
 CATEGORY 2: Acca, Cifrado, Clay, Fiord, Hallingdal, Karakorum, Moss, Steelcut, Steelcut Trio, Sunniva, Vanir, Vidar
 CATEGORY 3: Essential, Fuse, Mammuth, Voulez-Vous
 CATEGORY 4: Haze, Soft
 CATEGORY 5: Grace, Natural

SELECTED TEXTILE COLORS - SEE THE SURFACE SELECTION
 VANIR (193, 243, 373,393, 413, 443, 473, 693, 733, 773, 913, 983)

OPTIONS

DESCRIPTION	PRICE
Felt glides (4 pcs.) – added cost to chair price. See Spare Parts section for prices of extra felt glides	14
Linking device for 3108	119
Small transport dolly for 8 pcs. 3108 chairs, non-upholstered	679
Chair rack for 3108 chairs, mounted under a table top, for non-upholstered chairs only	99

3108

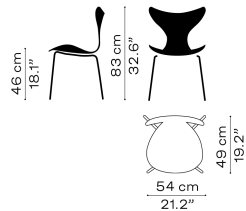

3208

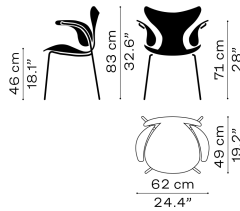

SMALL TRANSPORT DOLLY

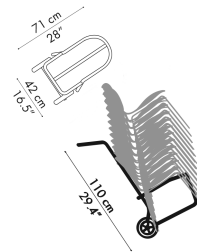



DROP™
ARNE JACOBSEN 1958/2014

01.2026

The Drop™ chair comes with a shell made of ABS plastic and four legs in chromed or powder coated tubular steel. The chair is also available upholstered in a wide range of textile and leather types.

PLASTIC

MODEL	DESCRIPTION	PLASTIC (ABS)
3110	Chair, 16.9" or 18.1", chromed or powder coated tubular steel base	499

PLASTIC COLOURS - SEE THE SURFACE SELECTION
DEEP CLAY, LIGHT BEIGE, PALE ROSE, OLIVE GREEN, BLACK, WHITE

BASE COLORS
WARM GRAPHITE, BROWN BRONZE, BLACK, WHITE (ONLY WITH WHITE SHELL), CHROME

FULLY UPHOLSTERED

MODEL	DESCRIPTION	CHRISTIANSHAVN	CATEGORY 1	CATEGORY 2	CATEGORY 3	CATEGORY 4	CATEGORY 5
3110	Chair, 16.9" or 18.1", handstitched, chromed or powder coated tubular steel base	1,499	1,599	1,699	2,699	2,899	3,399
3110UB	Chair, 16.9" or 18.1", Essential leather with front stitching and piping, chrome or powder coated tubular steel base				1,699		

CATEGORY 1: Canvas, Capture, Fame, Remix, Re-Wool, Technicolor, Tonus
 CATEGORY 2: Acca, Cifrado, Clay, Fiord, Hallingdal, Karakorum, Moss, Steelcut, Steelcut Trio, Sunniva, Vanir, Vidar
 CATEGORY 3: Aura, Essential, Fuse, Mammuth, Voulez-Vous
 CATEGORY 4: Haze
 CATEGORY 5: Grace, Natural

OPTIONS

DESCRIPTION	PRICE
Felt glides (4 pcs.) – added cost to chair price. See Spare Parts section for prices of extra felt glides	14
3110SC Seat cushion, Salsa 3 textile, grey (36)	89
3110SC Seat cushion, Salsa 3 textile, black (39)	89

3110/3110UB

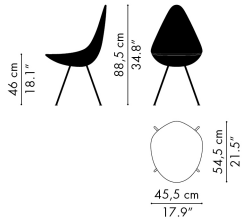



LITTLE GIRAFFE™
ARNE JACOBSEN 1959/2018

01.2026

The Little Giraffe™ chair is upholstered with either a fixed or a removable cover in a wide selection of textiles and leather types. Seat and backrest of the chair are made from PUR-foam molded around an inner steel frame. Its base is available either with four tubular steel legs or a five-star base made of die-cast aluminum.

MODEL	DESCRIPTION	CHRISTIANSHAVN	CATEGORY 1	CATEGORY 2	CATEGORY 3	CATEGORY 4	CATEGORY 5
3201	Chair, fixed cover, 4 legs, chromed or black powder coated tubular steel base	1,799	1,849	1,999	3,099	3,399	3,699
3201R	Chair, removable cover, 4 legs, chromed or black powder coated tubular steel base	1,949	2,099	2,199			
3211	Swivel chair, fixed cover, height-adjustable, satin brushed or black powder coated aluminum base, 5 castors	1,799	1,899	1,999	3,099	3,399	3,699
3211R	Swivel chair, removable cover, height-adjustable, satin brushed or black powder coated aluminum base, 5 castors	1,999	2,099	2,199			
32C	Removable cover, in textile only	519	549	619			

CATEGORY 1: Canvas, Capture, Fame, Remix, Re-Wool, Technicolor, Tonus
 CATEGORY 2: Acca, Cifrado, Clay, Fiord, Hallingdal, Karakorum, Moss, Steelcut, Steelcut Trio, Sunniva, Vanir, Vidar
 CATEGORY 3: Aura, Essential, Fuse, Mammuth, Voulez-Vous
 CATEGORY 4: Haze
 CATEGORY 5: Grace, Natural

BASE COLORS
 3201, 3201R: BLACK, CHROME
 3211, 3211R: BLACK, BRUSHED ALUMINIUM

OPTIONS

DESCRIPTION	PRICE
Hard castor for soft floors with or without brake	No surcharge
Soft castor for hard floors with or without brake	No surcharge

3201 / 3201R

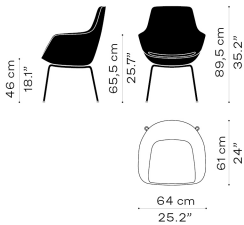

3211 / 3211R

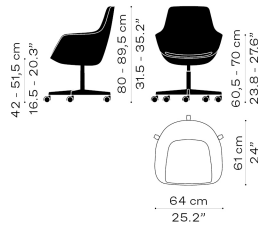



OXFORD™
ARNE JACOBSEN 1965

01.2026

The Oxford™ chair comes fully upholstered in a wide range of textile or leather types and is available with a low or medium back, with or without armrests. The inner shell of the chair is made of a pressure molded veneer shell covered with cut HR foam. The base of the chair is made of die-cast aluminum and available either as a fixed four-star or five-star base with or without castors, either fixed or height adjustable with tilt mechanism. The bases come in two finishes; satin brushed or powder coated aluminum, while the five-star base is also optionally available in mirror chrome. Optional comfort-enhancing arm pads are available for armrest configurations.

4-STAR BASE

MODEL	DESCRIPTION	CHRISTIANSHAVN	CATEGORY 1	CATEGORY 2	CATEGORY 3	CATEGORY 4	CATEGORY 5
3141T	Chair, low back, fixed seat height, toes	2,999	3,099	3,299	3,799	4,299	5,899
3143T	Chair, medium back, fixed seat height, toes	3,299	3,499	3,699	4,199	4,799	6,499
3241T	Armchair, low back, fixed seat height, toes	3,299	3,499	3,699	4,099	4,799	6,299
3243T	Armchair, medium back, fixed seat height, toes	3,699	2,899	3,999	4,499	5,099	6,799

5-STAR BASE

MODEL	DESCRIPTION	CHRISTIANSHAVN	CATEGORY 1	CATEGORY 2	CATEGORY 3	CATEGORY 4	CATEGORY 5
3171T	Chair, low back, fixed seat height, glides or toes	3,199	3,399	3,499	3,999	4,499	6,199
3173T	Chair, medium back, fixed height, glides or toes	3,499	3,699	3,899	4,399	4,999	6,699
3191T	Chair, low back, height adjustable, tilt, glides or toes	3,299	3,499	3,599	4,099	4,599	6,299
3193T	Chair, medium back, height adjustable, tilt, glides or toes	3,599	3,799	3,999	4,499	5,099	6,799
3271T	Armchair, low back, fixed seat height, glides or toes	3,499	3,699	3,899	4,299	4,899	6,499
3273T	Armchair, medium back, fixed seat height, glides or toes	3,899	4,099	4,299	4,699	5,299	6,999
3291T	Armchair, low back, height adjustable, tilt, glides or toes	3,699	3,799	3,999	4,399	4,999	6,599
3293T	Armchair, medium back, height adjustable, tilt, glides or toes	3,999	4,199	4,399	4,899	5,499	7,199

5-STAR BASE WITH CASTORS

MODEL	DESCRIPTION	CHRISTIANSHAVN	CATEGORY 1	CATEGORY 2	CATEGORY 3	CATEGORY 4	CATEGORY 5
3171W	Chair, low back, fixed seat height, castors	3,699	3,799	3,999	4,499	4,999	6,599
3173W	Chair, medium back, fixed seat height, castors	3,999	4,199	4,399	4,899	5,499	7,199
3191W	Chair, low back, height adjustable, tilt, castors	3,799	3,899	4,099	4,599	5,099	6,699
3193W	Chair, medium back, height adjustable, tilt, castors	4,099	4,299	4,499	4,999	5,599	7,299
3271W	Armchair, low back, fixed seat height, castors	3,999	4,199	4,399	4,799	5,299	6,999
3273W	Armchair, medium back, fixed seat height, castors	4,399	4,499	4,699	5,199	5,799	7,499
3291W	Armchair, low back, height adjustable, tilt, castors	4,099	4,299	4,499	4,899	5,499	7,099
3293W	Armchair, medium back, height adjustable, tilt, castors	4,499	4,599	4,799	5,299	5,899	7,599

CATEGORY 1: Canvas, Capture, Fame, Remix, Re-Wool, Technicolor, Tonus
 CATEGORY 2: Acca, Cifrado, Clay, Fiord, Hallingdal, Karakorum, Moss, Steelcut, Steelcut Trio, Sunniva, Vanir, Vidar
 CATEGORY 3: Essential, Fuse, Mammuth, Voulez-Vous
 CATEGORY 4: Haze, Soft
 CATEGORY 5: Grace, Natural

BASE COLORS: BROWN BRONZE, BLACK, SATIN BRUSHED ALUMINIUM

OPTIONS

DESCRIPTION	PRICE
Hard castor for soft floors with or without brake	No surcharge
Soft castor for hard floors with or without brake	No surcharge
Automatic return for chairs with fixed seat height	259
Arm pads in black plastic for chairs upholstered in textile	99
Arm pads in matching leather for chairs upholstered in leather	299
Mirror chromed base (5-star bases)	169
Mirror chromed base and armrests (5-star bases)	329



3141T

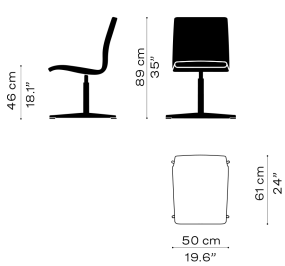

3143T

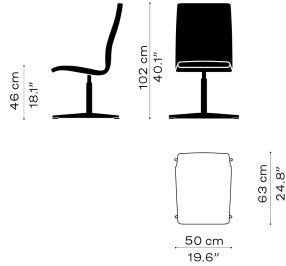

3241T

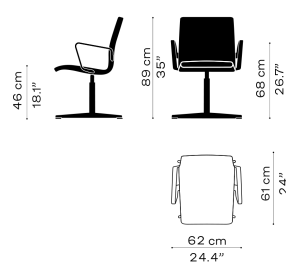

3243T

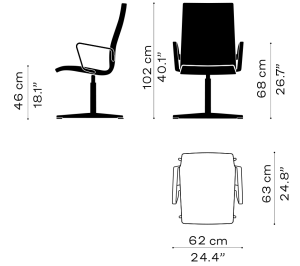

3171T

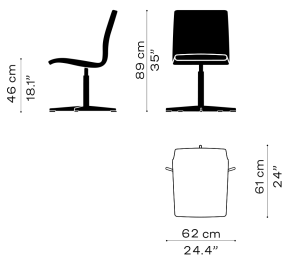

3173T

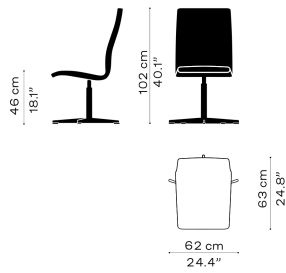

3191T

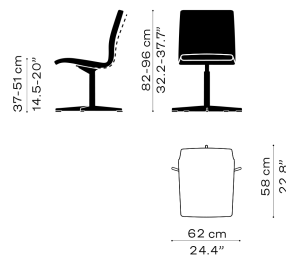

3193T

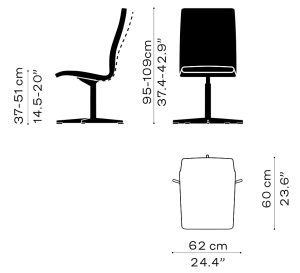

3271T

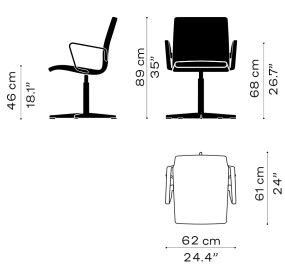

3273T

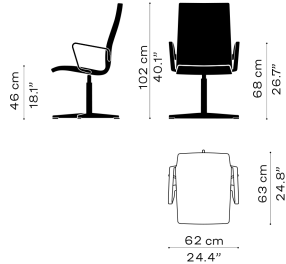

3291T

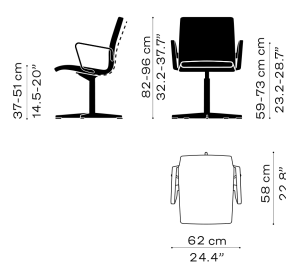

3293T

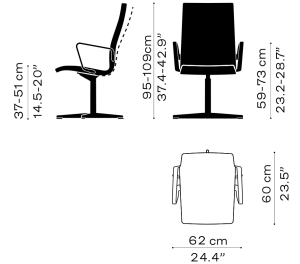

3171W

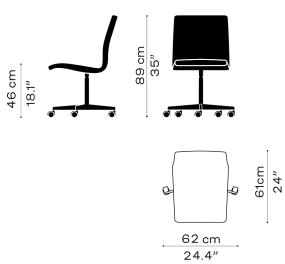

3173W

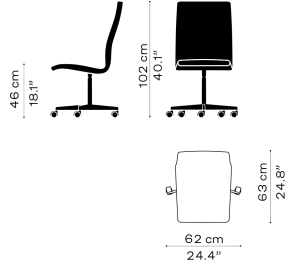

3191W

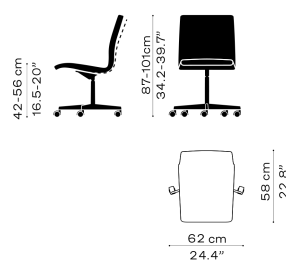

3193W

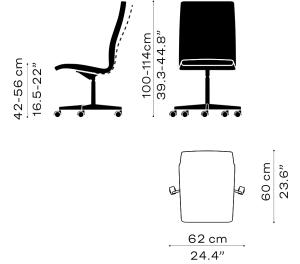

3271W

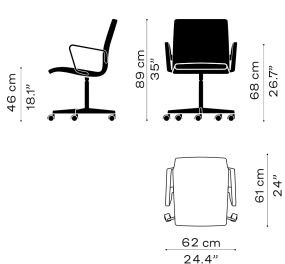

3273W

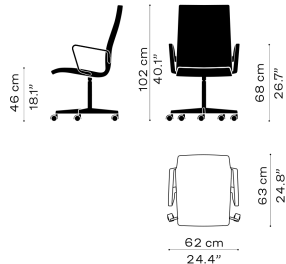

3291W

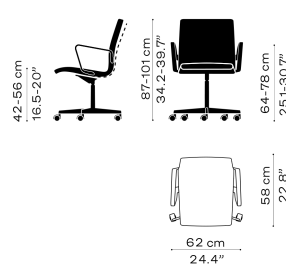

3293W

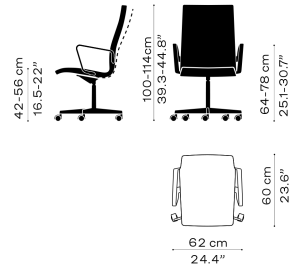



N02™ RECYCLE NENDO 2019

01.2026

N02™ Recycle is made from recycled plastic (PP) from household waste. It is available in seven shell colors with four legs made of tubular steel, a sledge base made of solid steel or a die-cast aluminum swivel base. The N02™ Recycle is also configurable as counter or bar stool with a four-legged base. The chair is available with an optional seat cushion in textile, mounted or purchased separately.

MODEL	DESCRIPTION	RECYCLED PLASTIC (PP)	PRICE
N02-10	Chair, stackable (max 10 pcs.), seat height 18.1", 4 legs, chromed or powder coated tubular steel		439
N02-11	Armchair, stackable (max 10 pcs.), seat height 18.1", 4 legs, chromed or powder coated tubular steel		589
N02-20	Chair, stackable (max 10 pcs.), seat height 18.1", chromed solid steel sledge base		439
N02-21	Chair w/welded linking device, stackable (max 10 pcs.), seat height 46 cm, chromed steel sledge base		519
N02-30	Swivel chair, polished aluminum base, 5 castors		779
N02-31	Swivel armchair, polished aluminum base, 5 castors		929
N02-40	Counter stool, stackable (max 4 pcs.), seat height 25.2", chromed or powder coated tubular steel base		529
N02-50	Bar stool, stackable (max 4 pcs.), seat height 29.9", chromed or powder coated tubular steel base		629

SHELL AND BASE COLORS
OFF WHITE, GREY, BLACK, DARK ORANGE, DARK RED, LIGHT BLUE, DARK BLUE

OPTIONS

DESCRIPTION	PRICE
Hard castor for soft floors with or without brake	No surcharge
Soft castor for hard floors with or without brake	No surcharge
N02-70 Seat cushion, Just textile in black (60999), dark grey (60121) or light grey (60118)	99
Linking device for N02-20	54
Felt glides (4 pcs.)	14
Small transport dolly for 10 pcs. N02-10, N02-11 or N02-20 chairs	679
Chair rack for N02 chairs, mounted under a table top	99

<p>N02-10</p>	<p>N02-11</p>	<p>N02-20</p>	<p>N02-21</p>	
<p>N02-30</p>	<p>N02-31</p>	<p>N02-40</p>	<p>N02-50</p>	<p>SMALL TRANSPORT DOLLY</p>

CERTIFICATION
The N02™ Recycle models N02-10 and N02-11 with powder coated legs have achieved the EU-Ecolabel.

EU Ecolabel
www.ecolabel.eu

EU Ecolabel : DK/049/009



VICO DUO™
VICO MAGISTRETTI 1997/2020

01.2026

The Vico Duo™ chair comes with a pressure molded veneer shell and is available in two different finishes: Clear lacquered (oak or walnut) or black colored ash (195) veneer. The shell is also available in front or fully upholstered versions in a wide range of textiles and leather types. Besides a four-legged tubular steel base, the Vico Duo™ is configurable with a sledge base made of solid steel, or as counter or bar stool with a four-legged tubular steel base. The chair is also available with a seat cushion in textile, mounted or purchased separately. Armrests are available on the models detailed below.

MODEL	DESCRIPTION	BLACK COLOURED ASH	CLEAR LACQUERED VENEER
VM110	Chair, stackable (max 10 pcs.), seat height 18.1", 4 legs, chromed or black powder coated tubular steel base	489	489
VM111	Armchair, stackable (max 8 pcs.), seat height 18.1", 4 legs, chromed or black powder coated tubular steel base	599	599
VM112	Chair w/welded linking device, stackable (max 8 pcs.), seat height 18.1", 4 legs, chromed or black powder coated tubular steel base	659	659
VM113	Armchair w/welded linking device, stackable (max 8 pcs.), seat height 18.1", 4 legs, chromed or black powder coated tubular steel base	819	819
VM114	Chair, stackable (max 8 pcs.), seat height 18.1", chromed steel sledge base	489	489
VM115	Chair w/welded linking device, stackable (max 8 pcs.), seat height 18.1", chromed steel sledge base	579	579
VM116	Counter stool, stackable (max 4 pcs.), seat height 25.2", chromed or black powder coated tubular steel base	619	619
VM118	Bar stool, stackable (max 4 pcs.), seat height 29.9", chromed or black powder coated tubular steel base	729	729

CLEAR LACQUERED VENEER: - SEE THE SURFACE SELECTION
OAK, WALNUT

FRONT UPHOLSTERED - BLACK COLORED ASH

MODEL	DESCRIPTION	CHRISTIANSHAVN	CATEGORY 1	CATEGORY 2	CATEGORY 3	CATEGORY 4	CATEGORY 5
VM110	Chair, seat height 18.1", 4 legs with arms, chromed or black powder coated tubular steel base	639	699	789	939	1,149	1,449
VM111	Armchair, seat height 18.", 4 legs, chromed or black powder coated tubular steel base	749	799	889	1,049	1,249	1,549
VM112	Chair w/welded linking device, seat height 18.1", 4 legs, chromed or black powder coated tubular steel base	819	869	949	1,099	1,299	1,599
VM113	Armchair w/welded linking device, seat height 18.1", 4 legs, chromed or black powder coated tubular steel base	949	999	1,099	1,249	1,449	1,749
VM114	Chair, seat height 18.1", chromed steel sledge base	639	699	789	939	1,149	1,449
VM115	Chair w/welded linking device, seat height 18.1", chromed steel sledge base	729	789	879	1,049	1,199	1,499
VM116	Counter stool, seat height 25.2", chromed or black powder coated tubular steel base	759	819	919	1,099	1,249	1,549
VM118	Bar stool, seat height 29.9", chromed or black powder coated tubular steel base	879	939	1,049	1,199	1,349	1,649

FRONT UPHOLSTERED - CLEAR LACQUERED VENEER

MODEL	DESCRIPTION	CHRISTIANSHAVN	CATEGORY 1	CATEGORY 2	CATEGORY 3	CATEGORY 4	CATEGORY 5
VM110	Chair, seat height 18.1", 4 legs with arms, chromed or black powder coated tubular steel base	639	699	789	939	1,149	1,449
VM111	Armchair, seat height 18.", 4 legs, chromed or black powder coated tubular steel base	749	799	889	1,049	1,249	1,549
VM112	Chair w/welded linking device, seat height 18.1", 4 legs, chromed or black powder coated tubular steel base	819	869	949	1,099	1,299	1,599
VM113	Armchair w/welded linking device, seat height 18.1", 4 legs, chromed or black powder coated tubular steel base	949	999	1,099	1,249	1,449	1,749
VM114	Chair, seat height 18.1", chromed steel sledge base	639	699	789	939	1,149	1,449
VM115	Chair w/welded linking device, seat height 18.1", chromed steel sledge base	729	789	879	1,049	1,199	1,499
VM116	Counter stool, seat height 25.2", chromed or black powder coated tubular steel base	759	819	919	1,099	1,249	1,549
VM118	Bar stool, seat height 29.9", chromed or black powder coated tubular steel base	879	939	1,049	1,199	1,349	1,649

CATEGORY 1: Belfast, Canvas, Capture, Fame, Remix, Re-Wool, Technicolor, Tonus
 CATEGORY 2: Acca, Cifrado, Clay, Fiord, Hallingdal, Karakorum, Moss, Steelcut, Steelcut Trio, Sunniva, Vanir, Vidar
 CATEGORY 3: Essential, Fuse, Mammuth, Voulez-Vous
 CATEGORY 4: Haze, Soft
 CATEGORY 5: Grace, Natural

SELECTED TEXTILE COLORS - SEE THE SURFACE SELECTION
 BELFAST (770593, 770660, 771772, 772062, 772143, 772150, 772255, 774232, 774926, 775139)



FULLY UPHOLSTERED

MODEL	DESCRIPTION	CHRISTIANSHAVN	CATEGORY 1	CATEGORY 2	CATEGORY 3	CATEGORY 4	CATEGORY 5
VM110	Chair, seat height 18.1", 4 legs with arms, chromed or black powder coated tubular steel base	719	779	869	1,099	1,399	1,949
VM111	Armchair, seat height 18.", 4 legs, chromed or black powder coated tubular steel base	819	879	969	1,199	1,499	2,099
VM112	Chair w/welded linking device, seat height 18.1", 4 legs, chromed or black powder coated tubular steel base	879	939	1,049	1,299	1,599	2,099
VM113	Armchair w/welded linking device, seat height 18.1", 4 legs, chromed or black powder coated tubular steel base	1,049	1,099	1,199	1,449	1,699	2,299
VM114	Chair, seat height 18.1", chromed steel sledge base	719	779	869	1,099	1,399	1,949
VM115	Chair w/welded linking device, seat height 18.1", chromed steel sledge base	819	869	949	1,199	1,499	2,099
VM116	Counter stool, seat height 25.2", chromed or black powder coated tubular steel base	839	889	979	1,249	1,549	2,099
VM118	Bar stool, seat height 29.9", chromed or black powder coated tubular steel base	949	999	1,099	1,349	1,649	2,199

CATEGORY 1: Belfast, Canvas, Capture, Fame, Remix, Re-Wool, Technicolor, Tonus
 CATEGORY 2: Acca, Cifrado, Clay, Fiord, Hallingdal, Karakorum, Moss, Steelcut, Steelcut Trio, Sunniva, Vanir, Vidar
 CATEGORY 3: Essential, Fuse, Mammuth, Voulez-Vous
 CATEGORY 4: Haze, Soft
 CATEGORY 5: Grace, Natural

SELECTED TEXTILE COLORS - SEE THE SURFACE SELECTION
 BELFAST (770593, 770660, 771772, 772062, 772143, 772150, 772255, 774232, 774926, 775139)

OPTIONS

DESCRIPTION	PRICE
Small transport dolly for 10 pcs. Vico Duo chairs without arms (except counter and bar stool) and 8 pcs. with arms, non-upholstered	679
Linking device for VM114	54
Felt glides (4 pcs.)	14
VM170 seat cushion, Just textile black (60999) or dark grey (60121)	94

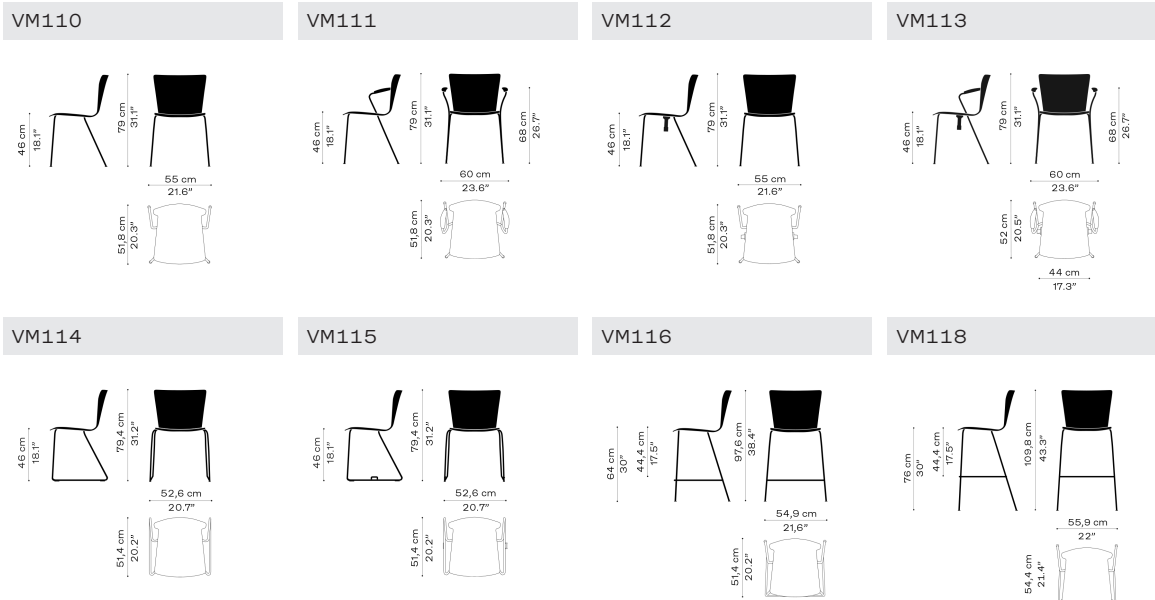

SMALL TRANSPORT DOLLY

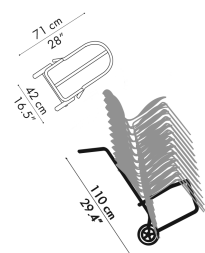



CHINA CHAIR™
HANS J. WEGNER 1944

01.2026

The China Chair™ is available in two types of solid wood: Clear lacquered cherry and black colored ash. The chair comes with an integrated loose seat cushion, upholstered in leather and available in various leather types.

MODEL	DESCRIPTION	CATEGORY 3	CATEGORY 5
4283	Armchair, seat height 17.7", solid wood, clear lacquered cherry	13,499	13,999
4283	Armchair, seat height 17.7", solid wood, black colored ash	10,999	11,499
4283SC	Replacement seat cushion (loose)	1,849	2,399

CATEGORY 3: Aura
 CATEGORY 5: Grace, Natural

4283

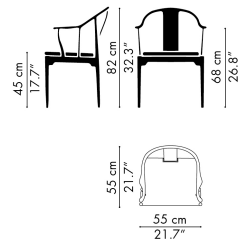



CARIMATE™
VICO MAGISTRETTI 1959

01.2026

Originally designed in 1959 for the Carimate golf club north of Milan, from which the chair takes its name, Vico Magistretti's bold and charismatic design became a highly prized collectable piece from the Italian designer's body of work. A strikingly memorable as well as comfortable chair, the Carimate™ is known for its bold personality and finely detailed construction. Magistretti's charismatic Carimate is available in untreated Beech and black colored Ash with paper cord seat as a pure and honest expression of the design icon. Perfect for creating a bold and memorable dining setting and a must-have for collectors of Magistretti works.

MODEL	DESCRIPTION	UNTREATED BEECH	BLACK COLOURED ASH
VM120	Armchair, seat height 45 cm	1,899	1,999

VM120

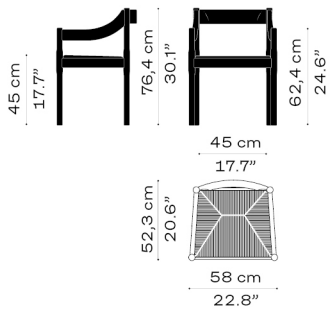



MONOLIT™
CECILIE MANZ 2024

01.2026

The Monolit™ by Cecilie Manz is a contemporary, distinct chair design made to elevate dining and lounge environments with its graceful elegance and tranquil expression. Available in two heights ideal for dining and lounging, its signature cocooning shape offers a welcoming embrace, providing both comfort and a sense of privacy, while the innovative design includes a space underneath for securely storing personal items.

MODEL	DESCRIPTION	CHRISTIANSHAVN	CATEGORY 1	CATEGORY 2	CATEGORY 3	CATEGORY 5
CM220	Dining chair, seat height 17.3", textile piping	1,999	2,299	2,699	3,099	
CM221	Dining chair, seat height 17.3", hand stitched leather piping	2,349	2,699	3,099	3,499	3,799

CATEGORY 1: Canvas, Capture, Fame, Remix, Re-Wool, Technicolor, Tonus
 CATEGORY 2: Acca, Cifrado, Clay, Fiord, Hallingdal, Karakorum, Moss, Steelcut, Steelcut Trio, Sunniva, Vanir, Vidar
 CATEGORY 3: Mammuth
 CATEGORY 5: Natural

CM220 / CM221

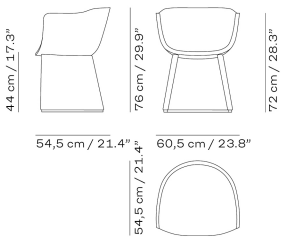



AFTER
MICHAEL ANASTASSIADES 2025

01.2026

The After series by Michael Anastassiades reinterprets classic design archetypes with sculptural clarity and generous proportions. Comprising a chair in clear ash or burgundy finish, and a table in ash with an optional red marble tabletop, the series brings quiet strength and refined presence to dining and lounge settings. An optional fitted cushion is available for the chair.

MODEL	DESCRIPTION	BURGUNDY COLOURED ASH	OILED ASH WHITE PIGMENTED
MA100	Chair, seat height 44,5 cm, solid wood	1,599	1,599

OPTIONS	DESCRIPTION	CATEGORY
MA100CU	Seat cushion (loose), Natural leather or Spectrum leather, Blackberry	5 389

MA100

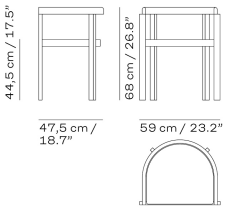

MA100CU

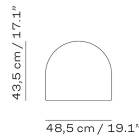



DIRECTOR'S CHAIR
SKAGERAK DESIGN

01.2026

Director's Chair is foldable, comfortable and beautiful to behold.

ITEM NO.	DESCRIPTION	PRICE
S1900585		879

CHAIR

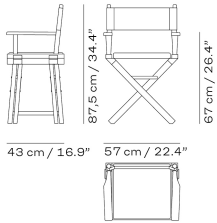



Hven is a collection of inviting and minimalist furniture with a natural Nordic look and feel. Hven is named after the Swedish island that lies in the strait between Denmark and Sweden. Designed in collaboration with contemporary Swedish designer, Anton Björnsing, the minimalistic collection is easy to mix with other furniture.

CHAIRS

ITEM NO.	DESCRIPTION	PRICE
1420010	Armchair, seat height 17.5", oak FSC 100%	1,049
1420010-2	Armchair, seat height 17.5", oak/white oil FSC 100%	1,199
1420010-3	Armchair, seat height 17.5", oak oil FSC 100%	1,199
1420026	Bar stool, seat height 26.4", oak FSC 100%	1,049
1420026-2	Bar stool, seat height 26.4", oak/white oil FSC 100%	1,249
1420026-3	Bar stool, seat height 26.4", oil oak FSC 100%	1,249

CUSHIONS CHAIRS

ITEM NO.	DESCRIPTION	PRICE
1950530	Chair cushion, cognac, Dunes Aniline leather	329
1950539	Chair cushion, cognac, Dunes Aniline leather, UK	329
1961038	Bar stool cushion, Dunes Aniline leather, cognac	319
1950555	Bar stool cushion, Dunes Aniline leather, cognac, UK	319

CHAIR

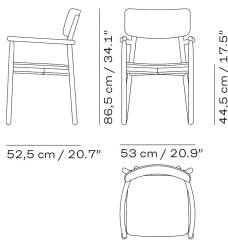

BAR STOOL

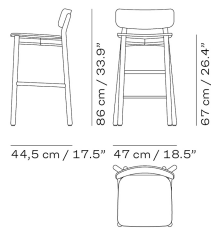

CUSHION CHAIR

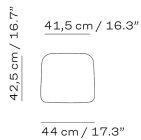

CUSHION BAR STOOL

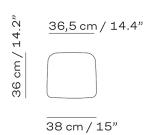



VESTER
CHRIS LILJENBERG HALSTRØM

01.2026

A dining chair designed in a well-proportioned idiom, the Vester Chair combines beauty and elegance with function and comfort. A transverse brass rod at the back indicates where to pull out the chair. Legs continuing up into the backrest form a small hook for hanging a purse or small item. The chair's body in golden oiled 100% FSC-certified oak naturally contrasts the fine brass detailing in this award-winning piece.

CHAIRS

ITEM NO.	DESCRIPTION	PRICE
1092000-3	Chair, seat height 17.5", oil oak/brass, FSC 100%	1,249

CUSHIONS CHAIRS

ITEM NO.	DESCRIPTION	PRICE
1961069	Chair cushion, Dunes leather, cognac, UK	329
1961070	Chair cushion, Dunes leather, cognac	329

CHAIR

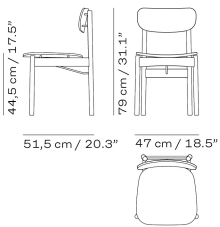

CUSHION CHAIR

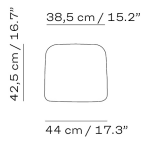



SERIES 3300™
ARNE JACOBSEN 1956

01.2026

Series 3300™ is available both as a lounge chair and a 2- or 3-seater sofa. Its frame is made of chromed tubular steel, while the cushions are made of cut HR foam covering a wooden base structure. The cushions come fully upholstered in a wide range of textiles and leather types.

MODEL	DESCRIPTION	CHRISTIANSHAVN	CATEGORY 1	CATEGORY 2	CATEGORY 3	CATEGORY 4	CATEGORY 5
3300	Lounge chair, chromed tubular steel base	6,999	7,299	7,799	10,999	10,999	15,999

CATEGORY 1: Canvas, Capture, Fame, Remix, Re-Wool, Technicolor, Tonus
 CATEGORY 2: Acca, Cifrado, Clay, Fiord, Hallingdal, Karakorum, Moss, Steelcut, Steelcut Trio, Sunniva, Vanir, Vidar
 CATEGORY 3: Aura, Essential, Fuse, Mammuth, Voulez-Vous
 CATEGORY 4: Haze
 CATEGORY 5: Grace, Natural

3300

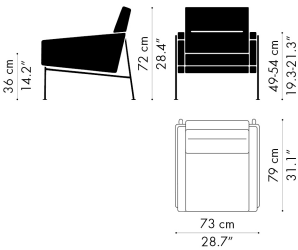



EGG™
ARNE JACOBSEN 1958

01.2026

The Egg™ lounge chair comes fully upholstered in a wide range of textiles and leather types. The four-star base consists either of a satin chromed steel column connected to a base in satin brushed aluminum or a powder coated steel column connected to a base in powder coated aluminum. The inner shell is made of a hard molded foam, padded with a softer foam structure to increase comfort. A matching Egg™ footstool is available in the same base and upholstery options as the Egg™ lounge chair.

MODEL	DESCRIPTION	CHRISTIANSHAVN	CATEGORY 1	CATEGORY 2	CATEGORY 3	CATEGORY 4	CATEGORY 5
3316	Lounge chair, 4-star base, tilt and swivel	10,499	10,999	11,499	14,499	15,999	17,499
3127	Footstool, 4-star base	3,199	3,299	3,399	3,699	4,099	4,699

CATEGORY 1: Canvas, Capture, Fame, Re-Wool, Technicolor, Tonus
 CATEGORY 2: Acca, Cifrado, Clay, Fiord, Hallingdal, Karakorum, Moss, Steelcut, Steelcut Trio, Sunniva, Vanir, Vidar
 CATEGORY 3: Aura, Essential, Fuse, Mammuth, Voulez-Vous
 CATEGORY 4: Haze
 CATEGORY 5: Grace, Natural

BASE COLORS
 SILVER GREY, WARM GRAPHITE, BROWN BRONZE, BLACK, BRUSHED ALUMINIUM

OPTIONS

DESCRIPTION	PRICE
Automatic return for 3316	279

3316

3127

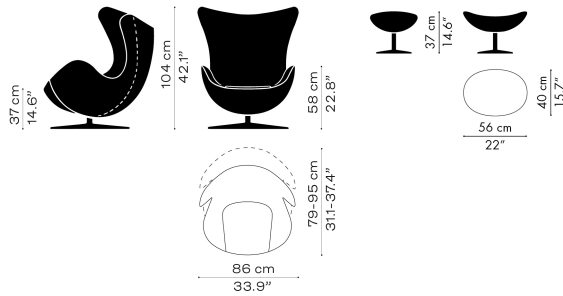



SWAN™
ARNE JACOBSEN 1958

01.2026

The Swan™ lounge chair comes fully upholstered in a wide range of textiles and leather types. The four-star base consists either of a satin chromed steel column connected to a base in satin brushed aluminum or a powder coated steel column connected to a base in powder coated aluminum. The inner shell is made of a hard molded foam, padded with a softer foam structure to increase comfort.

MODEL	DESCRIPTION	CHRISTIANSHAVN	CATEGORY 1	CATEGORY 2	CATEGORY 3	CATEGORY 4	CATEGORY 5
3320	Lounge chair, 4-star base, swivel	5,799	6,099	6,499	7,899	8,799	9,799

CATEGORY 1: Capture, Fame, Remix, Re-Wool, Technicolor, Tonus
 CATEGORY 2: Acca, Cifrado, Fiord, Hallingdal, Karakorum, Moss, Steelcut, Steelcut Trio, Sunniva, Vanir, Vidar
 CATEGORY 3: Aura, Essential, Mammuth, Voulez-Vous
 CATEGORY 4: Haze
 CATEGORY 5: Grace, Natural

BASE COLORS
 SILVER GREY, WARM GRAPHITE, BROWN BRONZE, BLACK, BRUSHED ALUMINIUM

DESCRIPTION	PRICE
Automatic return for 3320	279
Special seat height: 18.9"	79

3320	3320 + 3.2"
------	-------------

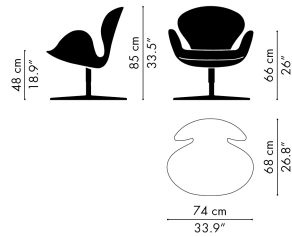
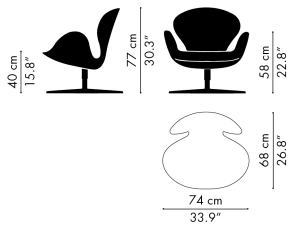



OKSEN™
ARNE JACOBSEN 1966

01.2026

Oksen™ lounge chair comes in three different leather types: Aura and Grace in the colors black and walnut as well as in Essential leather. The five-star base is available in black powder coated aluminum or satin brushed aluminum with a satin brushed steel column. A matching Oksen™ footstool is available in the same base and upholstery options as the Oksen™ lounge chair.

MODEL	DESCRIPTION	CATEGORY 3	CATEGORY 4	CATEGORY 5
4201	Lounge chair, swivel, satin brushed aluminum or black powder coated aluminum	14,999	18,999	21,499
4210	Footstool, satin brushed aluminum or black powder coated aluminum	3,799	4,599	5,099

CATEGORY 3: Aura, Essential
CATEGORY 4: Haze
CATEGORY 5: Grace, Natural

OPTIONS

DESCRIPTION	PRICE
Automatic return for 4201	279

4201

4210

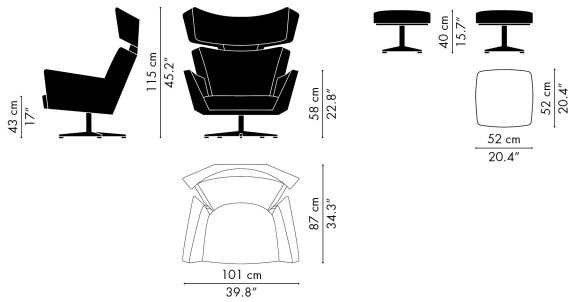



POT™
ARNE JACOBSEN 1959/2017

01.2026

The Pot™ lounge chair comes fully upholstered in a wide range of textiles and leather types. The inner shell is made of a hard molded foam, padded with a softer foam structure to increase comfort. The lounge chair's base consists of four legs in chromed or Brown Bronze powder coated tubular steel.

MODEL	DESCRIPTION	CHRISTIANSHAVN	CATEGORY 1	CATEGORY 2	CATEGORY 3	CATEGORY 4	CATEGORY 5
3318	Lounge chair, chromed or brown bronze powder coated tubular steel base	2,599	2,699	2,999	3,999	4,699	5,499

CATEGORY 1: Canvas, Capture, Fame, Remix, Re-Wool, Technicolor, Tonus
 CATEGORY 2: Acca, Cifrado, Clay, Fiord, Hallingdal, Karakorum, Moss, Steelcut, Steelcut Trio, Sunniva, Vanir, Vidar
 CATEGORY 3: Aura, Essential, Fuse, Mammuth, Voulez-Vous
 CATEGORY 4: Haze
 CATEGORY 5: Grace, Natural

3318

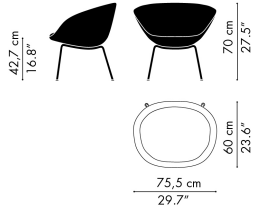



LISSONI SOFA™
PIERO LISSONI 2006

The Lisconi Sofa™ is a fully upholstered sofa series and comes in a variety of sizes and corner configurations. The sofa cushions consist of a core of cut foam and a channel sewed comfort-enhancing cover stuffed with synthetic flakes and feathers. The frame is either made of matt brushed stainless steel or powder coated steel. The Lisconi Sofa™ is available in a wide range of textiles and leather types.

MATT BRUSHED STAINLESS STEEL FRAME

MODEL	DESCRIPTION	CHRISTIANSHAVN	CATEGORY 1	CATEGORY 2	CATEGORY 3	CATEGORY 4	CATEGORY 5
PL111S	Lounge chair	5,399	5,699	6,299	7,499	8,199	10,499
PL111	Lounge chair	6,299	6,999	7,099	8,199	9,499	12,499

CATEGORY 1: Canvas, Capture, Fame, Remix, Re-Wool, Technicolor, Tonus
 CATEGORY 2: Acca, Cifrado, Clay, Fiord, Hallingdal, Karakorum, Moss, Steelcut, Steelcut Trio, Sunniva, Vanir, Vidar
 CATEGORY 3: Essential, Fuse, Mammuth, Voulez-Vous
 CATEGORY 4: Haze, Soft
 CATEGORY 5: Grace, Natural

PL111S

PL111

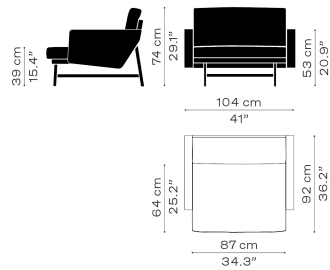
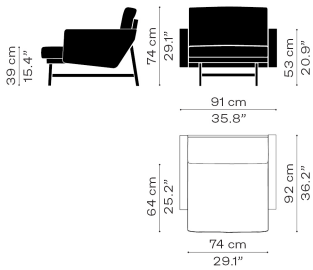



RO™
JAIME HAYON 2013

01.2026

The Ro™ lounge chair comes fully upholstered in a wide range of textiles. Single textile or a mix of two textiles; one textile for the shell and one for the cushions. The base is available with four legs in brushed aluminum or solid oak with a clear lacquer finish. A matching Ro™ footstool is available in the same base and upholstery options as the Ro™ lounge chair.

MODEL	DESCRIPTION	CHRISTIANSHAVN	CATEGORY 1	CATEGORY 2	CATEGORY 3
JH1	Lounge chair, brushed aluminum legs	4,599	4,799	4,799	6,199
JH2	Lounge chair, solid oak legs	4,599	4,799	4,799	6,199
JH11	Footstool, brushed aluminum legs	1,349	1,449	1,449	1,749
JH12	Footstool, solid oak legs	1,349	1,449	1,449	1,749

CATEGORY 1: Canvas, Capture, Fame, Remix, Re-Wool, Technicolor, Tonus
 CATEGORY 2: Acca, Cifrado, Clay, Fiord, Hallingdal, Karakorum, Moss, Steelcut, Steelcut Trio, Sunniva, Vanir, Vidar
 CATEGORY 3: Fuse, Mammuth, Voulez-Vous

NOTE:
 THE TEXTILES VOULEZ-VOUS AND FUSE ARE AVAILABLE FOR CUSHIONS ONLY, NOT APPLICABLE FOR SHELL UPHOLSTERY

JH1

JH2

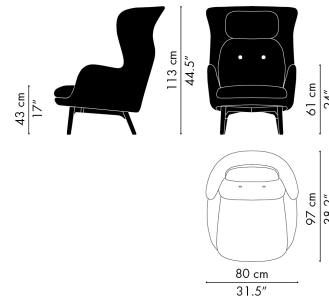
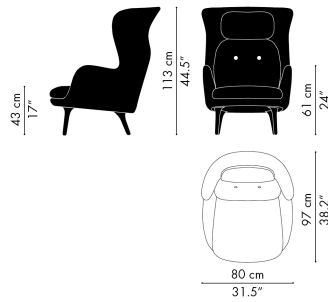

JH11

JH12

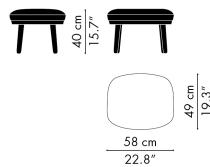
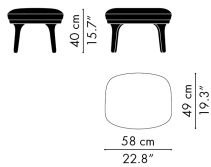



Fri™ is offered as a lounge chair, sofa, and footstool, and is fully upholstered in a diverse selection of textiles. Choose between tapered legs in aluminium or solid oak, and opt for a single textile or a combination of two textiles.

MODEL	DESCRIPTION	CHRISTIANSHAVN	CATEGORY 1	CATEGORY 2	CATEGORY 3
JH4	Lounge chair, brushed aluminium legs	3,899	4,099	4,099	5,199
JH5	Lounge chair, solid oak legs	4,099	4,399	4,399	5,199
JH14	Footstool, brushed aluminum legs	1,299	1,349	1,349	1,749
JH15	Footstool, solid oak legs	1,349	1,449	1,449	1,749

CATEGORY 1: Canvas, Capture, Fame, Remix, Re-Wool, Technicolor, Tonus
 CATEGORY 2: Acca, Cifrado, Clay, Fiord, Hallingdal, Karakorum, Moss, Steelcut, Steelcut Trio, Sunniva, Vanir, Vidar
 CATEGORY 3: Fuse, Mammuth, Voulez-Vous

NOTE:
 THE TEXTILES VOULEZ-VOUS AND FUSE ARE AVAILABLE FOR CUSHIONS ONLY, NOT APPLICABLE FOR SHELL UPHOLSTERY

JH4

JH5

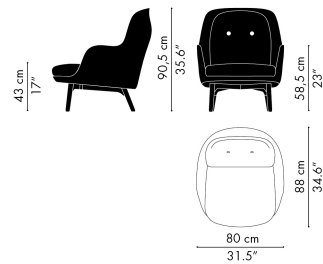
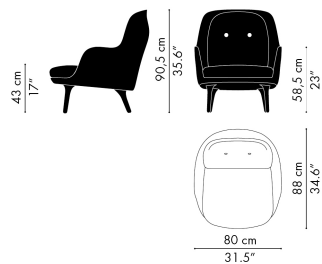

JH14

JH15

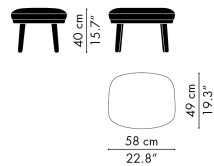
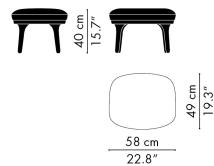



VIA57™
BJARKE INGELS IN COLLABORATION WITH KIBISI 2016

01.2026

VIA57™ lounge chair comes fully upholstered in a range of textiles. The wooden base is made of solid oak with a clear lacquer finish. Seat and back are composed of soft molded PE foam around an inner steel frame.

MODEL	DESCRIPTION	CHRISTIANSHAVN	CATEGORY 1	CATEGORY 2	CATEGORY 3
BIO1	Lounge chair, solid oak base	3,699	3,699	3,799	4,599

CATEGORY 1: Canvas, Capture, Fame, Remix, Re-Wool, Technicolor, Tonus
 CATEGORY 2: Acca, Cifrado, Clay, Fiord, Hallingdal, Karakorum, Moss, Steelcut, Steelcut Trio, Sunniva, Vanir, Vidar
 CATEGORY 3: Mammuth

BIO1

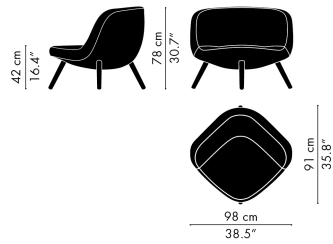



FRED™
JAIME HAYON 2019

The Fred™ lounge chair is available in two types of solid wood and a total of four different finishes: Black colored ash, clear lacquered (oak or walnut stained oak) or oiled oak. The upholstered cushions are available in a variety of textile and leather types.

MODEL	DESCRIPTION	CHRISTIANSHAVN	CATEGORY 1	CATEGORY 2	CATEGORY 3	CATEGORY 4	CATEGORY 5
JH97	Lounge chair, Black colored oak	3,199	3,399	3,499	4,099	4,799	5,799
JH97	Lounge chair, Walnut stained oak	3,199	3,399	3,499	4,099	4,799	5,799
JH97	Lounge chair, Clear lacquered oak	3,399	3,499	3,699	4,199	4,899	5,899
JH97	Lounge chair, Natural oiled oak	3,399	3,499	3,699	4,199	4,899	5,899

CATEGORY 1: Canvas, Capture, Fame, Remix, Re-Wool, Technicolor, Tonus
 CATEGORY 2: Acca, Cifrado, Clay, Fiord, Hallingdal, Karakorum, Moss, Steelcut, Steelcut Trio, Sunniva, Vanir, Vidar
 CATEGORY 3: Aura, Essential, Fuse, Mammuth, Voulez-Vous
 CATEGORY 4: Haze, Soft
 CATEGORY 5: Grace, Natural

JH97

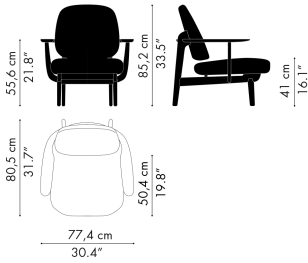



The Let™ lounge chair comes fully upholstered and is available in a wide range of textiles and leather. Inner seat and backrest of the chair are made from PUR-foam molded around an inner steel frame. The four-legged base of the Let™ lounge chair is available either in solid wood or tubular steel. The wooden bases come with a clear lacquered oak, clear lacquered ash or black colored ash finish, while steel bases are available in chrome or powder coated in Black, Warm Graphite or Brown Bronze.

MODEL	DESCRIPTION	CHRISTIANSHAVN	CATEGORY 1	CATEGORY 2	CATEGORY 3	CATEGORY 4	CATEGORY 5
SH200	Lounge chair, wooden base	2,699	2,799	2,899	3,199	3,699	4,499
SH210	Lounge chair, chromed or powder coated tubular steel base	2,599	2,699	2,799	3,099	3,599	4,299
SH220	Lounge chair, swivel base in bright polished or powder coated aluminium	2,999	3,199	3,299	3,499	3,899	4,699

CATEGORY 1: Belfast, Canvas, Capture, Fame, Remix, Re-Wool, Technicolor, Tonus
 CATEGORY 2: Acca, Cifrado, Clay, Fiord, Hallingdal, Karakorum, Moss, Steelcut, Steelcut Trio, Sunniva, Vanir, Vidar
 CATEGORY 3: Aura, Essential, Fuse, Mammuth, Voulez-Vous
 CATEGORY 4: Haze, Soft
 CATEGORY 5: Grace, Natural

BASE COLORS
 SH200: CLEAR LACQUERED OAK, CLEAR LACQUERED ASH OR BLACK COLOURED ASH
 SH210: BROWN BRONZE, BLACK, CHROME
 SH220: BRIGHT POLISHED ALUMINIUM, BLACK

SH200

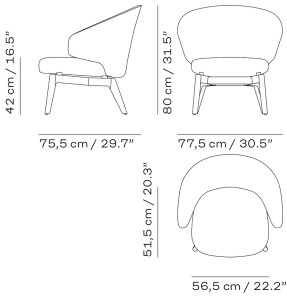

SH210

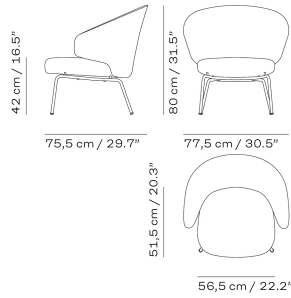

SH220

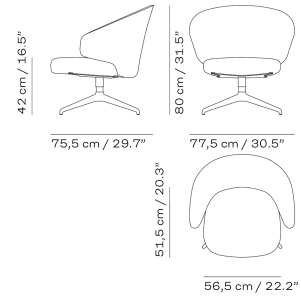



MONOLIT™
CECILIE MANZ 2024

The Monolit™ by Cecilie Manz is a contemporary, distinct chair design made to elevate dining and lounge environments with its graceful elegance and tranquil expression. Available in two heights ideal for dining and lounging, its signature cocooning shape offers a welcoming embrace, providing both comfort and a sense of privacy, while the innovative design includes a space underneath for securely storing personal items.

DESCRIPTION	CHRISTIANSHAVN	CATEGORY 1	CATEGORY 2	CATEGORY 3	CATEGORY 5
CM230 Lounge chair, seat height 15.4", textile piping	1,999	2,299	2,699	3,099	-
CM231 Lounge chair, seat height 15.4", hand stitched leather piping	2,349	2,699	3,099	3,499	3,799

CATEGORY 1: Canvas, Capture, Fame, Remix, Re-Wool, Technicolor, Tonus
 CATEGORY 2: Acca, Cifrado, Clay, Fiord, Hallingdal, Karakorum, Moss, Steelcut, Steelcut Trio, Sunniva, Vanir, Vidar
 CATEGORY 3: Mammuth
 CATEGORY 5: Natural

CM230 / CM231

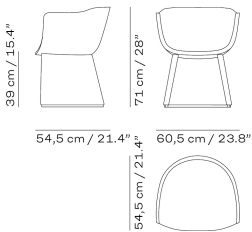

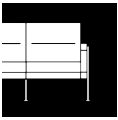

SERIES 3300™
ARNE JACOBSEN 1956

01.2026

Series 3300™ is available as both a lounge chair and a 2- or 3-seater sofa. Its frame is made of chromed tubular steel, while the cushions are made of cut HR foam covering a wooden base structure. The cushions come fully upholstered in a wide range of textiles and leather types.

MODEL	DESCRIPTION	CHRISTIANSHAVN	CATEGORY 1	CATEGORY 2	CATEGORY 3	CATEGORY 4	CATEGORY 5
3302	2-seater, chrome tubular steel base	10,499	10,999	11,499	16,499	19,499	22,999
3303	3-seater, chromed tubular steel base	13,999	14,499	15,499	21,499	25,499	29,999
	Additional modules for Series 3300, chromed tubular steel base	3,399	3,599	3,799	5,399	5,999	6,999

CATEGORY 1: Canvas, Capture, Fame, Remix, Re-Wool, Technicolor, Tonus
 CATEGORY 2: Acca, Cifrado, Clay, Fiord, Hallingdal, Karakorum, Moss, Steelcut, Steelcut Trio, Sunniva, Vanir, Vidar
 CATEGORY 3: Aura, Essential, Fuse, Mammuth, Voulez-Vous
 CATEGORY 4: Haze
 CATEGORY 5: Grace, Natural

3302

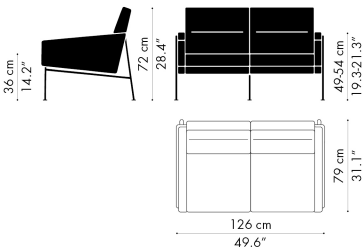

3303

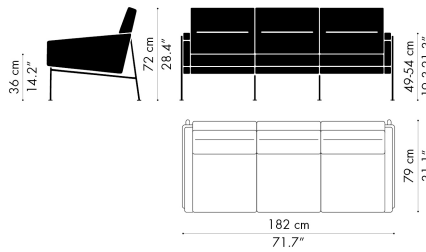



SWAN SOFA™
ARNE JACOBSEN 1958

01.2026

The Swan™ sofa comes fully upholstered in a wide range of textiles and leather types. The sofa rests on a shaker base in satin brushed aluminum. The inner shell is made of a hard molded foam, padded with a comfort-enhancing foam structure with lower density.

MODEL	DESCRIPTION	CHRISTIANSHAVN	CATEGORY 1	CATEGORY 2	CATEGORY 3	CATEGORY 4	CATEGORY 5
3321	2-seater, shaker base, satin brushed aluminum	12,499	12,999	13,999	17,999	17,999	23,499

CATEGORY 1: Canvas, Capture, Fame, Re-Wool, Technicolor, Tonus
 CATEGORY 2: Acca, Cifrado, Fiord, Hallingdal, Karakorum, Moss, Steelcut, Steelcut Trio, Sunniva, Vanir, Vidar
 CATEGORY 3: Aura, Essential, Mammuth, Voulez-Vous
 CATEGORY 4: Haze
 CATEGORY 5: Grace, Natural

3321

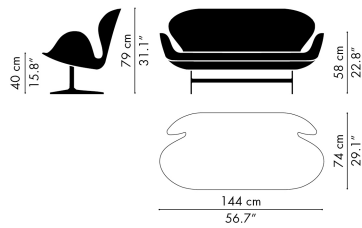



The Lissoni Sofa™ is a fully upholstered sofa and comes in a variety of sizes and corner configurations. The sofa cushions consist of a core of cut foam and a channel sewed comfort-enhancing cover stuffed with synthetic flakes and feathers. The frame is either made of matt brushed stainless steel or powder coated steel. The Lissoni Sofa™ is available in a wide range of textiles and leather types.

MATT BRUSHED STAINLESS STEEL FRAME

MODEL	DESCRIPTION	CHRISTIANSHAVN	CATEGORY 1	CATEGORY 2	CATEGORY 3	CATEGORY 4	CATEGORY 5
PL110S	Pouf	2,349	2,599	2,899	3,399	3,799	4,699
PL110	Pouf	2,799	2,899	3,299	3,799	4,199	5,299
PL112S	2-seater sofa, length 65.4"	8,399	8,899	10,499	11,999	12,999	16,999
PL112	2-seater sofa, length 77.2"	10,499	10,999	12,999	14,499	15,999	20,999
PL113S	3-seater sofa, length 94.9"	12,499	13,499	14,999	17,499	18,999	24,999
PL113	3-seater sofa, length 112.6"	15,499	16,499	17,499	20,499	22,499	28,999
PL114S	4-seater corner sofa, left / right	16,999	17,499	19,499	22,999	25,499	32,999
PL114	4-seater corner sofa, left / right	17,999	18,999	21,499	24,999	27,499	36,499
PL115S	5-seater corner sofa	19,499	20,499	22,999	26,499	29,499	37,999
PL115	5-seater corner sofa	21,499	22,999	25,499	29,499	32,999	42,499
PL116S	5-seater corner sofa, left / right	21,499	22,999	24,999	28,999	32,499	41,999
PL116	5-seater corner sofa, left / right	24,499	25,999	27,499	31,999	35,499	45,999
PL117S	6-seater corner sofa, left / right	23,499	24,499	27,499	31,999	35,499	45,499
PL117	6-seater corner sofa, left / right	25,999	27,499	30,999	35,499	38,999	50,999
PL118S	7-seater corner sofa	27,499	28,499	32,499	37,499	40,999	53,499
PL118	7-seater corner sofa	29,499	32,499	35,499	40,999	46,999	58,999

CATEGORY 1: Canvas, Capture, Fame, Remix, Re-Wool, Technicolor, Tonus
 CATEGORY 2: Acca, Cifrado, Clay, Fiord, Hallingdal, Karakorum, Moss, Steelcut, Steelcut Trio, Sunniva, Vanir, Vidar
 CATEGORY 3: Essential, Fuse, Mammuth, Voulez-Vous
 CATEGORY 4: Haze, Soft
 CATEGORY 5: Grace, Natural

PL110S

PL110

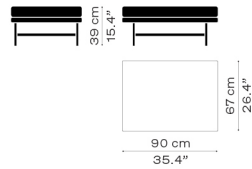
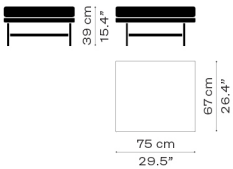



PL112S

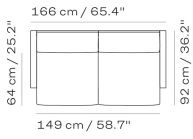

PL112

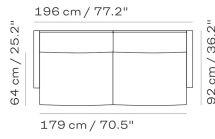

PL113S

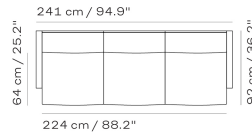

PL113

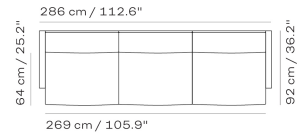

PL114S L

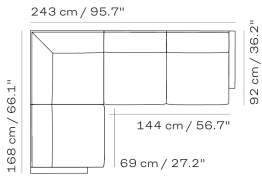

PL114S R

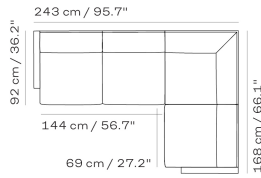

PL114 L

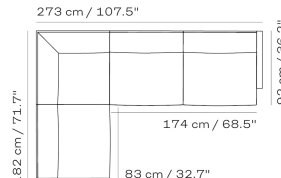

PL114 R

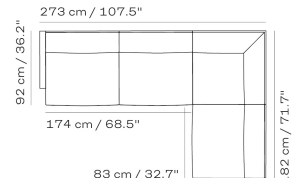

PL115S

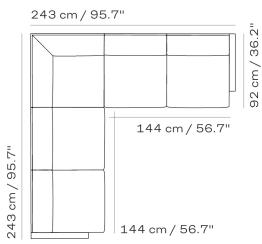

PL115

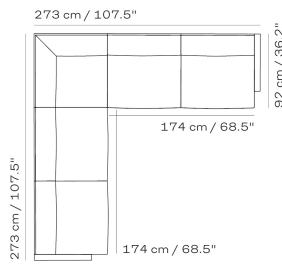

PL116S L

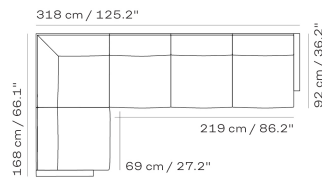

PL116S R

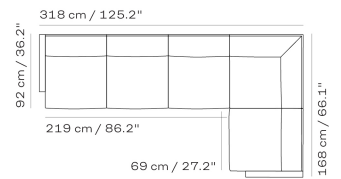

PL116 L

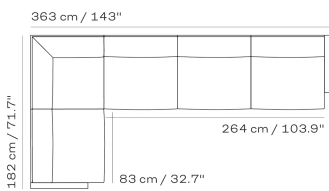

PL116 R

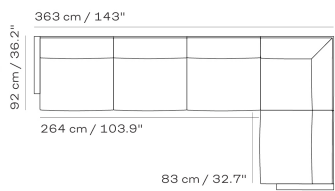

PL117S L

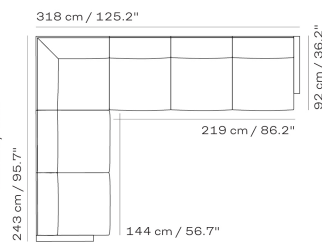

PL117S R

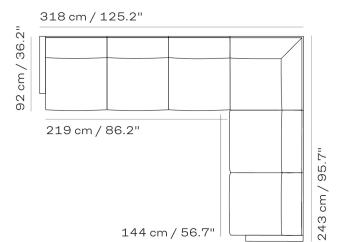

PL117 L

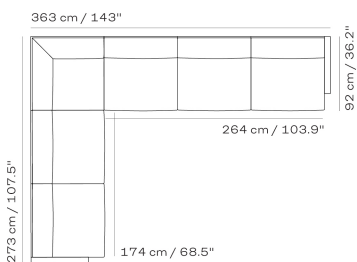

PL117 R

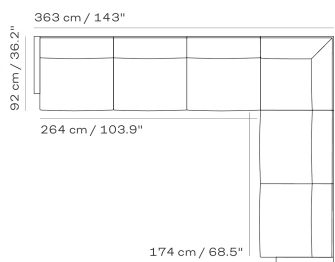

PL118S

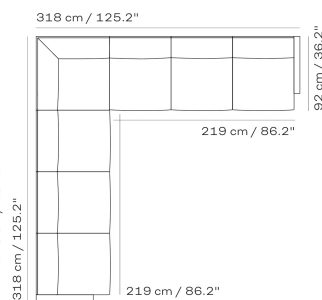

PL118

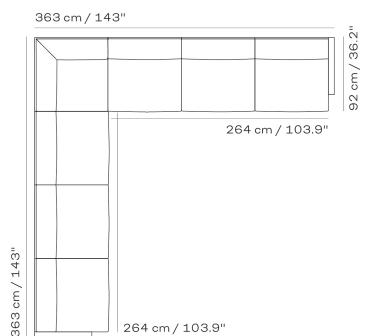



ALPHABET™ SOFA SERIES
PIERO LISSONI 2008

01.2026

The Alphabet™ Sofa Series is a modular sofa system with units that can be combined in a variety of ways. The fully upholstered seat, back and armrest units come in a wide range of textiles, which can be removed for cleaning or replacement. You can choose to include a piping along the edges on both seat, back and armrests.

MODEL	DESCRIPTION	CHRISTIANSHAVN	CATEGORY 1	CATEGORY 2
PL210-1	2-seater sofa, 1 corner backrest, 1 backrest, 1 armrest	7,599	7,999	8,399
PL210-2	2-seater sofa, 1 corner backrest, 1 backrest, 1 armrest	7,599	7,999	8,399
PL210-3	2-seater sofa, 1 corner backrest, 1 backrest	6,699	6,999	7,399
PL210-4	2-seater sofa, 1 corner backrest, 1 backrest	6,699	6,999	7,399
PL240-1	2-seater sofa, 1 backrest, 2 armrests	7,699	8,099	8,499
PL240-2	2-seater sofa, 1 corner backrest, 1 backrest, 1 armrest	8,099	8,499	8,999
PL240-3	2-seater sofa, 1 corner backrest, 1 backrest, 1 armrest	8,099	8,499	8,999
PL240-4	2-seater sofa, 1 corner backrest, 1 backrest	6,999	7,399	7,799
PL240-5	2-seater sofa, 1 corner backrest, 1 backrest	6,999	7,399	7,799
PL255-1	3-seater sofa, 1 backrest, 2 armrests	8,999	9,499	9,999
PL270-1	3-seater sofa, 1 backrest, 2 armrests	9,299	9,799	10,499
PL300-1	3-seater sofa, 1 corner backrest, 2 backrests, 1 armrest	10,499	10,999	11,499
PL300-2	3-seater sofa, 1 corner backrest, 2 backrests, 1 armrest	10,499	10,999	11,499
PL300-3	4-seater sofa, 1 corner backrest, 2 backrests	11,999	12,499	13,499
PL300-4	4-seater sofa, 1 corner backrest, 2 backrests	11,999	12,499	13,499

BASE UNITS - SEAT

MODEL	DESCRIPTION	CHRISTIANSHAVN	CATEGORY 1	CATEGORY 2
PL75-105	Sofa seat unit	1,749	1,799	1,899
PL90-105	Sofa seat unit	1,899	1,999	2,099
PL120-105	Sofa seat unit	2,199	2,299	2,399
PL120-120	Sofa seat unit	2,399	2,499	2,699

BASE UNITS - BACK

MODEL	DESCRIPTION	CHRISTIANSHAVN	CATEGORY 1	CATEGORY 2
PL75-30	Sofa back unit	919	969	999
PL90-30	Sofa back unit	1,049	1,099	1,149
PL120-30	Sofa back unit	1,149	1,199	1,249
PL150-30	Sofa back unit	1,349	1,449	1,499
PL180-30	Sofa back unit	1,499	1,599	1,699
PL240-30	Sofa back unit	1,749	1,849	1,949
PL255-30	Sofa back unit	1,899	1,999	2,099
PL270-30	Sofa back unit	1,999	2,099	2,199
PL90-90-30	Corner backrest	1,399	1,499	1,549

BASE UNITS - ARMREST

MODEL	DESCRIPTION	CHRISTIANSHAVN	CATEGORY 1	CATEGORY 2
PL60-30	Armrest	819	869	899

MODEL	DESCRIPTION	CHRISTIANSHAVN	CATEGORY 1	CATEGORY 2
PLO01	Additional sofa cushion (1 pcs.)	249	259	289

CATEGORY 1: Canvas, Capture, Fame, Remix, Re-Wool, Technicolor, Tonus
 CATEGORY 2: Acca, Cifrado, Clay, Fiord, Hallingdal, Karakorun, Moss, Steelcut, Steelcut Trio, Sunniva, Vanir, Vidar

ALPHABET COVERS ARE AVAILABLE FOR ALL MODULES AT 35% OF THE MODULE PRICE
 PIPING ALONG THE EDGES ON BOTH SEAT, BACK AND ARMRESTS IS AVAILABLE AT NO ADDITIONAL COST



PL210-1

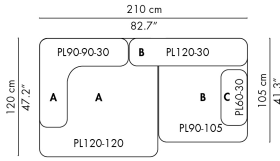

PL210-2

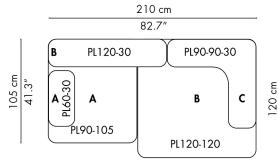

PL210-3

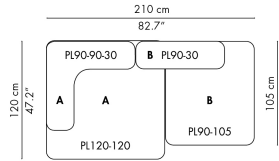

PL210-4

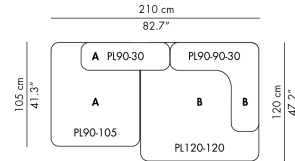

PL240-1

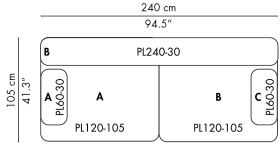

PL240-2

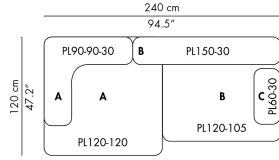

PL240-3

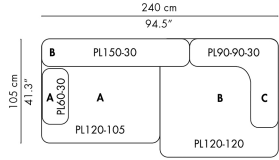

PL240-4

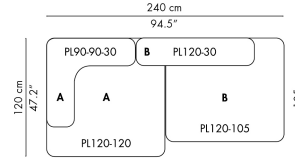

PL240-5

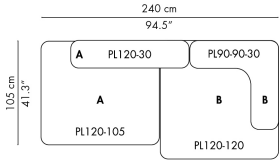

PL255-1

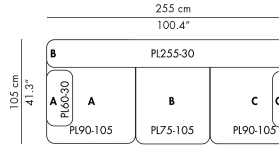

PL270-1

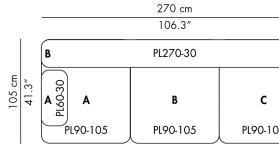

PL300-1

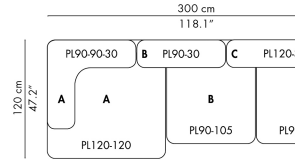

PL300-2

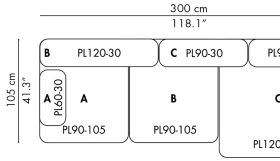

PL300-3

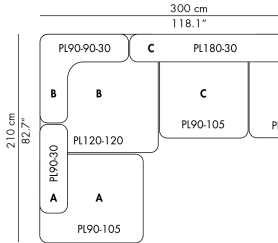

PL300-4

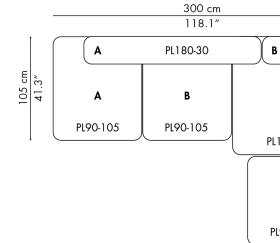

PL75-105

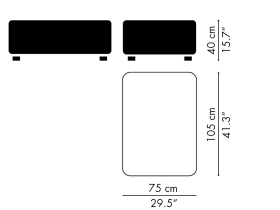

PL90-105

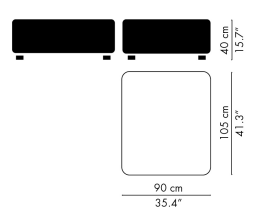

PL120-105

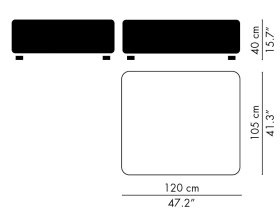

PL120-120

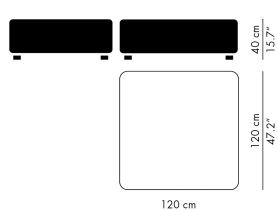

PL90-90-30

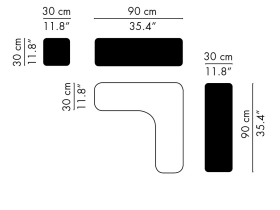

PL75-30

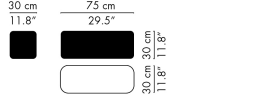

PL90-30



PL120-30

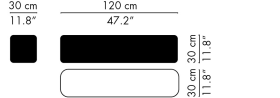

PL150-30

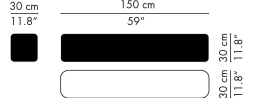

PL180-30

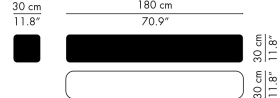

PL240-30

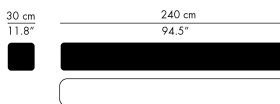

PL255-30

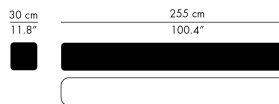

PL270-30

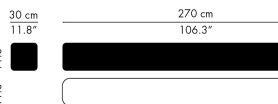

PL60-30

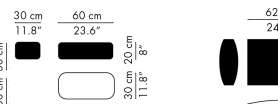

PL001

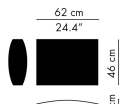



RO™ SOFA
JAIME HAYON 2017

01.2026

The Ro™ Sofa comes fully upholstered in a wide range of textiles. As a single textile or a mix of two textiles; one textile for the shell and one for the cushions. The base consists of four legs in brushed aluminum or is available wooden base in solid oak with a clear lacquer finish.

MODEL	DESCRIPTION	CHRISTIANSHAVN	CATEGORY 1	CATEGORY 2	CATEGORY 3
JH110	2-seater sofa, brushed aluminum legs	9,299	9,799	9,799	12,999
JH120	2-seater sofa, solid oak base	9,999	10,499	10,499	13,999

CATEGORY 1: Canvas, Capture, Fame, Remix, Re-Wool, Technicolor, Tonus
 CATEGORY 2: Acca, Cifrado, Clay, Fiord, Hallingdal, Karakorum, Moss, Steelcut, Steelcut Trio, Sunniva, Vanir, Vidar
 CATEGORY 3: Mammuth

JH110

JH120

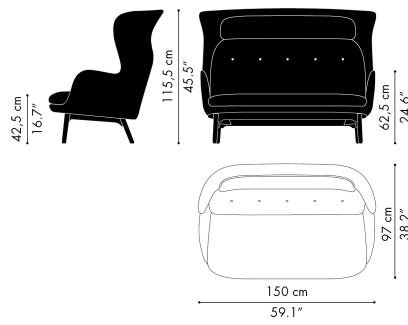
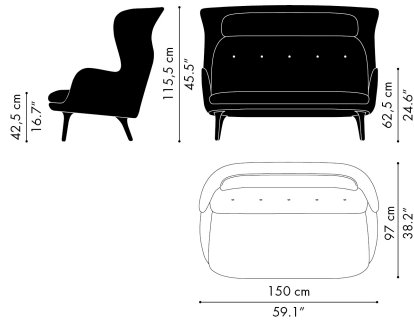



FRI™ SOFA
JAIME HAYON 2024

01.2026

Fri™ is offered as a lounge chair, sofa, and footstool, and is fully upholstered in a diverse selection of textiles. Choose between tapered legs in aluminium or solid oak, and opt for a single textile or a combination of two textiles.

MODEL	DESCRIPTION	CHRISTIANSHAVN	CATEGORY 1	CATEGORY 2	CATEGORY 3
JH140	2-seater sofa, brushed aluminium legs	5,899	6,299	6,899	8,899
JH150	2-seater sofa, solid oak legs	5,899	6,299	6,899	8,899

CATEGORY 1: Canvas, Capture, Fame, Remix, Re-Wool, Technicolor, Tonus
 CATEGORY 2: Acca, Cifrado, Clay, Fiord, Hallingdal, Karakorum, Moss, Steelcut, Steelcut Trio, Sunniva, Vanir, Vidar
 CATEGORY 3: Mammuth

JH140

JH150

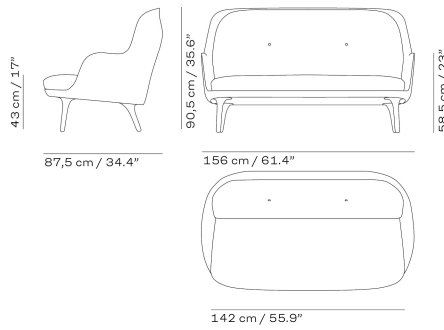
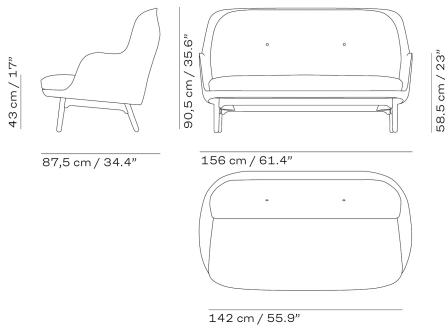



PLENUM™
JAIME HAYON 2018

01.2026

Plenum™ is a high-back sofa system available in one-, two-, or three-seater versions, as well as a Cabin model. The standard sofa options include features such as power plugs and mounted side tables, with two table variants available. The Plenum Cabin supports optional screen mounting plate, power plugs, USB ports, and additional table options.

SOFA		CHRISTIANSHAVN	CATEGORY 1	CATEGORY 2
MODEL	DESCRIPTION			
JH1001	1-seater sofa, black powder coated steel base	8,499	8,899	9,699
JH1002	2-seater sofa, black powder coated steel base	10,999	11,499	12,499
JH1003	3-seater sofa, black powder coated steel base	12,999	13,999	14,499

CATEGORY 1: Canvas, Capture, Fame, Remix, Re-Wool, Technicolor, Tonus
 CATEGORY 2: Acca, Cifrado, Clay, Fiord, Hallingdal, Karakorum, Moss, Steelcut, Steelcut Trio, Sunniva, Vanir, Vidar

CABIN		CHRISTIANSHAVN	CATEGORY 1	CATEGORY 2
MODEL	DESCRIPTION			
JH1004M	4-seater cabin, black powder coated steel base	22,999	23,499	24,499
JH1004MU	4-seater cabin with table (JH71), black powder coated steel base	23,499	23,999	24,999
JH1004M	4-seater cabin with table (JH72) and screen-ready, black powder coated steel base	23,999	24,999	25,499

CATEGORY 1: Canvas, Capture, Fame, Remix, Re-Wool, Technicolor, Tonus
 CATEGORY 2: Acca, Cifrado, Clay, Fiord, Hallingdal, Karakorum, Moss, Steelcut, Steelcut Trio, Sunniva, Vanir, Vidar

TABLES		LAMINATE (POLYREY)
MODEL	DESCRIPTION	
JH70	Side sofa table, light grey laminate, black powder coated steel base	1,349
JH71	Table, light grey laminate, without power solution, black powder coated steel base	979
JH72	Table, light grey laminate, with power solution, black powder coated steel base	-
JH75	Coffee table, light grey laminate, black powder coated steel base	1,649
JH80	Table, light grey laminate, black powder coated steel base	1,899

OPTIONS		PRICE
DESCRIPTION		
PU01, Power unit for sofa, black (1 pcs., available in select markets only)		799



JH1001

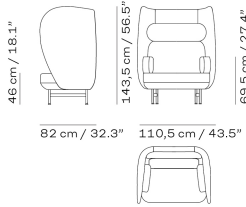

JH1002

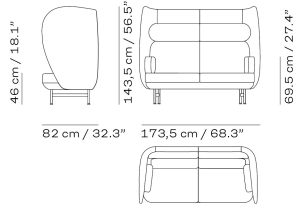

JH1003

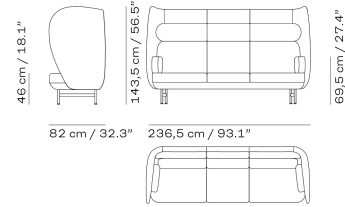

JH1004MU

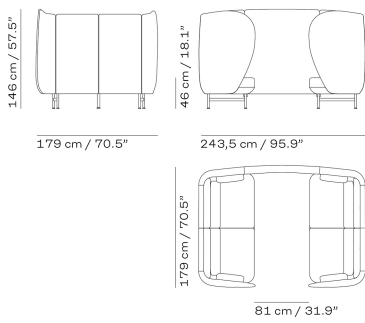

JH1004MUT (JH71)

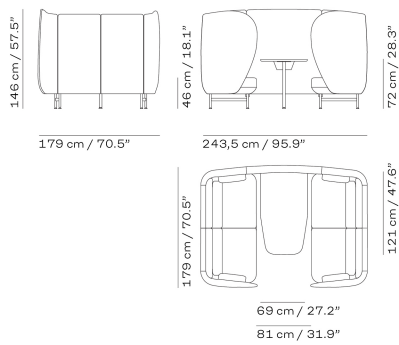

JH1004MUTS (JH72)

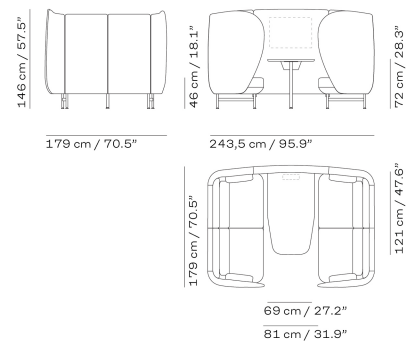

JH70

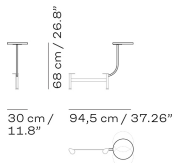

JH75

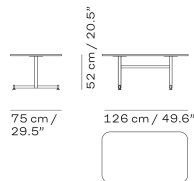

JH80

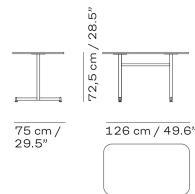

PU01



PU02

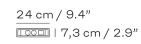



SUPERELLIPSE™
PIET HEIN/BRUNO MATHSSON 1968

01.2026

The Superellipse™ tables are available in various sizes and with a tabletop made of either Fenix laminate or clear lacquered walnut veneer. While laminate versions come with an aluminum edge, the walnut veneer versions come with a natural wooden edge. The table's iconic span legs are available either in chromed or powder coated steel.

DINING TABLES (HEIGHT 28.3")

MODEL	DESCRIPTION	FENIX LAMINATE	CLEAR LACQUERED WALNUT	H/L/W
B611	Table, span legs, detachable	3,099	4,499	
B612	Table, span legs, detachable	3,399	4,799	28.3/59.1/39.4
B616	Table, span legs, detachable	3,599	5,199	28.3/66.9/39.4
B613	Table, span legs, detachable	3,899	5,899	28.3/70.9/47.2
B614	Table, span legs, detachable	5,199	7,799	28.3/94.5/47.2
B617	Table, span legs, detachable	7,999	11,999	28.3/118.1/51.2
B6180	Table, span legs, detachable	3,999	5,999	
B6200	Table, span legs, detachable	4,599	6,699	
B6240	Table, span legs, detachable	5,299	7,999	

EXTENSION TABLES (HEIGHT 28.3")

MODEL	DESCRIPTION	FENIX LAMINATE	CLEAR LACQUERED WALNUT	H/L/W
B620	Table, span legs, detachable	7,199	11,499	28.3/66.9(106.3)/39.4
B619	Table, span legs, detachable	7,699	12,999	28.3/70.9(118.1)/47.2

OPTIONS

DESCRIPTION	PRICE
Span legs, table height 27.5" (B4) or 29.1" (B8)	149

FENIX LAMINATE COLORS - SEE THE SURFACE SELECTION
 WHITE, GREY, BLACK, BROWN OTTAWA, GREY BROMO, GREY EFESO

SPAN LEGS COLORS
 SILVER GREY, WARM GRAPHITE, BROWN BRONZE, BLACK, WHITE, CHROME

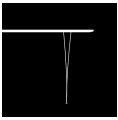

B611

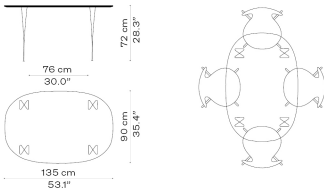

B612

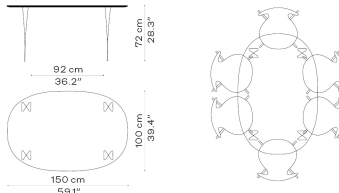

B616

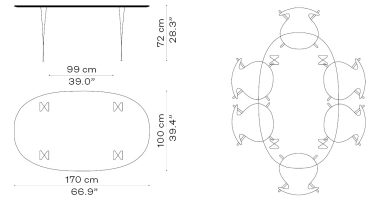

B613

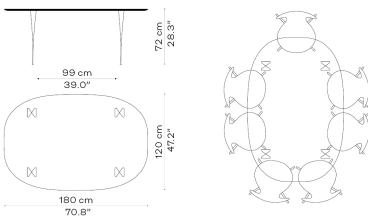

B614

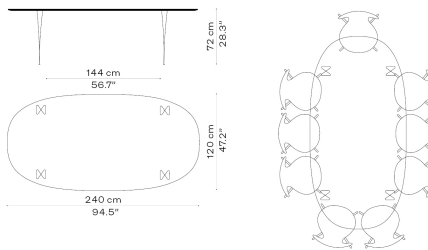

B617

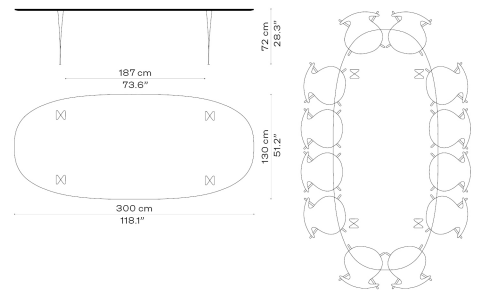

B6180

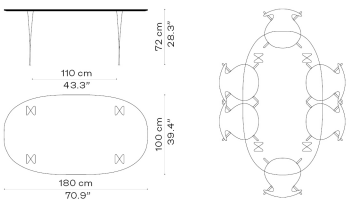

B6200

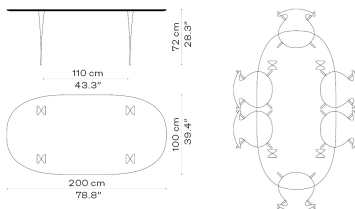

B6240

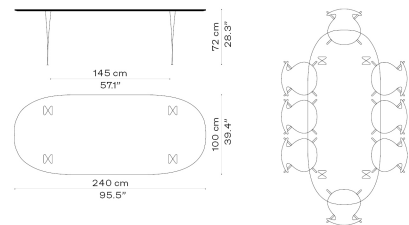

B620

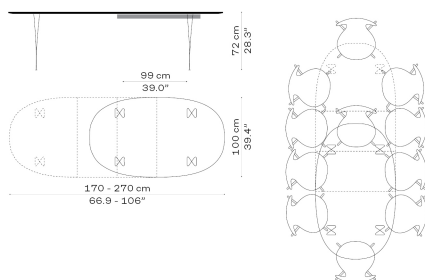

B619

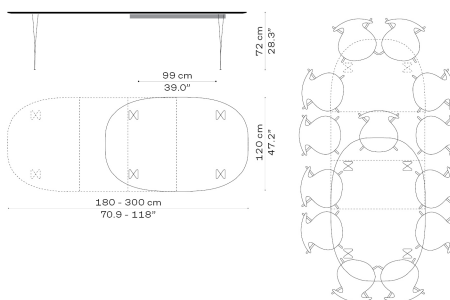



SUPERCIRCULAR™
PIET HEIN/BRUNO MATHSSON/ARNE JACOBSEN 1968

01.2026

The Supercircular™ tables are available in various sizes and with a tabletop made of either r Fenix laminate or clear lacquered walnut veneer. While laminate versions come with an aluminum edge, the walnut veneer versions come with a natural wooden edge. The four-star base is made of either satin brushed aluminum with a satin chromed steel pedestal or powder coated aluminum with matching steel pedestal. One table configuration is also available with the iconic span legs that come either in chromed or powder coated steel. The Supercircular™ tables are also configurable as coffee or bar table.

DINING TABLES (HEIGHT 28.3")

MODEL	DESCRIPTION	FENIX LAMINATE	CLEAR LACQUERED WALNUT	H/L/W
A602	Table (Ø:75 cm), pedestal base, 4-star	2,349	3,299	28.3/29.5/29.5
A603	Table (Ø:100 cm), pedestal base, 4-star	2,899	3,899	28.3/39.4/39.4
B603	Table (Ø:100 cm), span legs, detachable	2,999	4,099	28.3/39.4/39.4

COFFEE TABLES (HEIGHT 18")

MODEL	DESCRIPTION	FENIX LAMINATE	CLEAR LACQUERED WALNUT	H/L/W
A202	Coffee table (Ø:75 cm), pedestal base, 4-star	2,199	2,999	18/29.5/29.5
A203	Coffee table (Ø:100 cm), pedestal base, 4-star	2,599	3,599	18/39.4/39.4

BAR TABLES (HEIGHT 42.5")

MODEL	DESCRIPTION	FENIX LAMINATE	CLEAR LACQUERED WALNUT	H/L/W
A902	Bar table (Ø:75 cm), pedestal base, 4-star	2,599	3,499	42.5/29.5/29.5

OPTIONS

DESCRIPTION	PRICE
Pedestal base 4-star, table height 18.5" (A2), Table height, 42.5" (A9 - only for Ø 29.5" table top)	149
Span legs, table height 27.5" (B4) or 29.1" (B8)	149

FENIX LAMINATE COLORS - SEE THE SURFACE SELECTION
WHITE, GREY, BLACK, BROWN OTTAWA, GREY BROMO, GREY EFESO

PEDESTAL BASE COLORS
SILVER GREY, BROWN BRONZE, BLACK, SATIN BRUSHED ALUMINIUM

SPAN LEGS COLORS
SILVER GREY, WARM GRAPHITE, BROWN BRONZE, BLACK, WHITE, CHROME

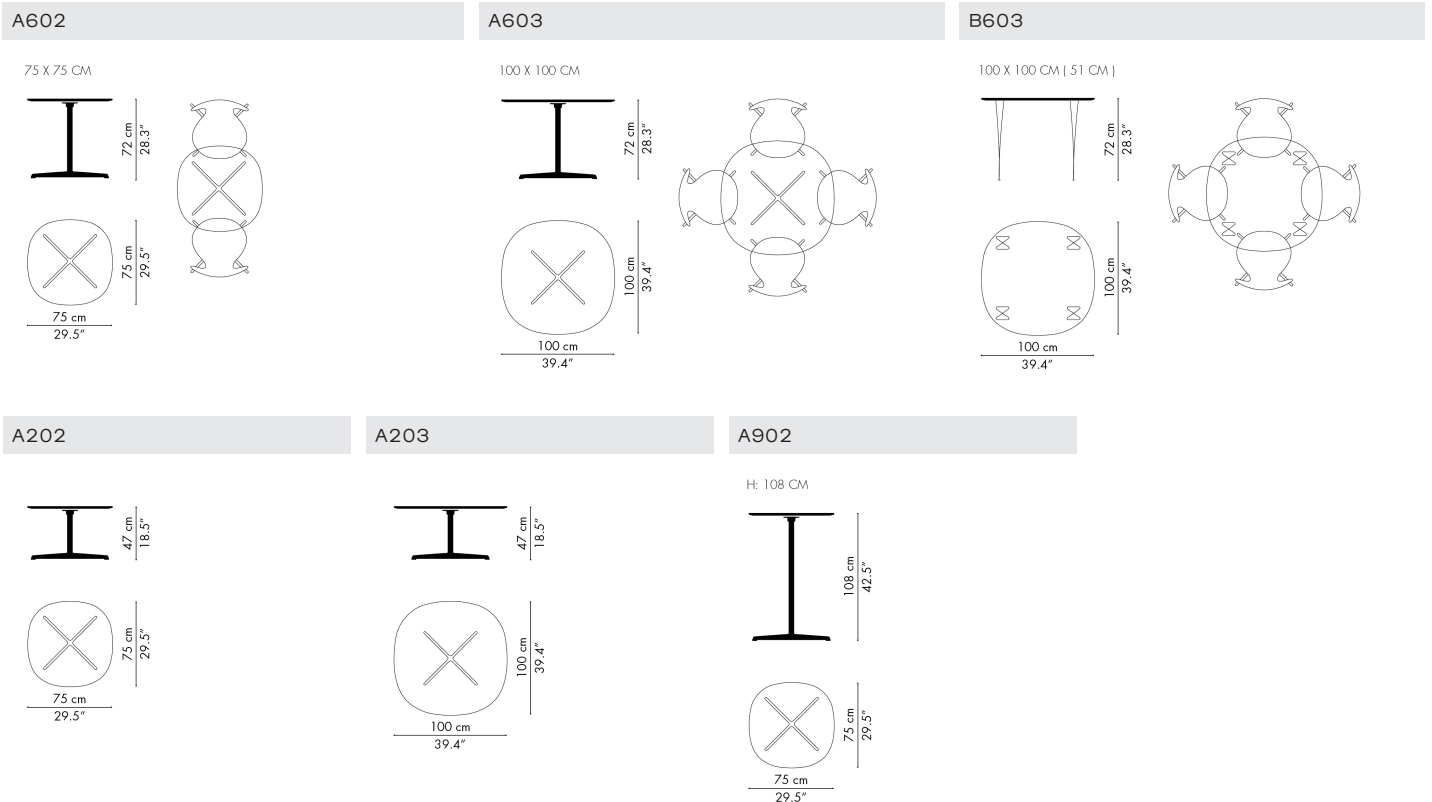



The Circular tables are available in various sizes and with a tabletop made of either Fenix laminate or clear lacquered walnut veneer. While laminate versions come with an aluminium edge, the walnut veneer versions come with a natural wooden edge. The four-star base is made of either satin brushed aluminium with a satin chromed steel pedestal or powder coated aluminium with matching steel pedestal. The Circular tables are also configurable as coffee or bar table.

DINING TABLES (HEIGHT 28.3")

MODEL	DESCRIPTION	FENIX LAMINATE	CLEAR LACQUERED WALNUT	H/Ø
A622	Table, pedestal base, 4-star	2,199	2,899	28.3/29.5
A623	Table, pedestal base, 4-star	2,699	3,499	28.3/35.4
A825	Table, pedestal base, 6-star	3,999	5,399	28.3/47.2
A826	Table, pedestal base, 6-star	5,299	6,199	28.3/57.1

COFFEE TABLES (HEIGHT 18")

MODEL	DESCRIPTION	FENIX LAMINATE	CLEAR LACQUERED WALNUT	H/Ø
A222	Coffee table, pedestal base, 4-star	2,099	2,699	18/29.5
A223	Coffee table, pedestal base, 4-star	2,499	3,199	18/35.4

BAR TABLE (HEIGHT 42.5")

MODEL	DESCRIPTION	FENIX LAMINATE	CLEAR LACQUERED WALNUT	H/Ø
A922	Bar table, pedestal base, 4-star	2,599	3,199	42.5/29.5

FENIX LAMINATE COLOURS - SEE THE SURFACE SELECTION
WHITE, GREY, BLACK, BROWN OTTAWA, GREY BROMO, GREY EFESO

PEDESTAL BASE COLORS
SILVER GREY, BROWN BRONZE, BLACK, SATIN BRUSHED ALUMINIUM

OPTIONS

DESCRIPTION	PRICE
Pedestal base 4-star, table height 18.5" (A2), Table height, 42.5" (A9 - only for Ø 29.5" table top)	149

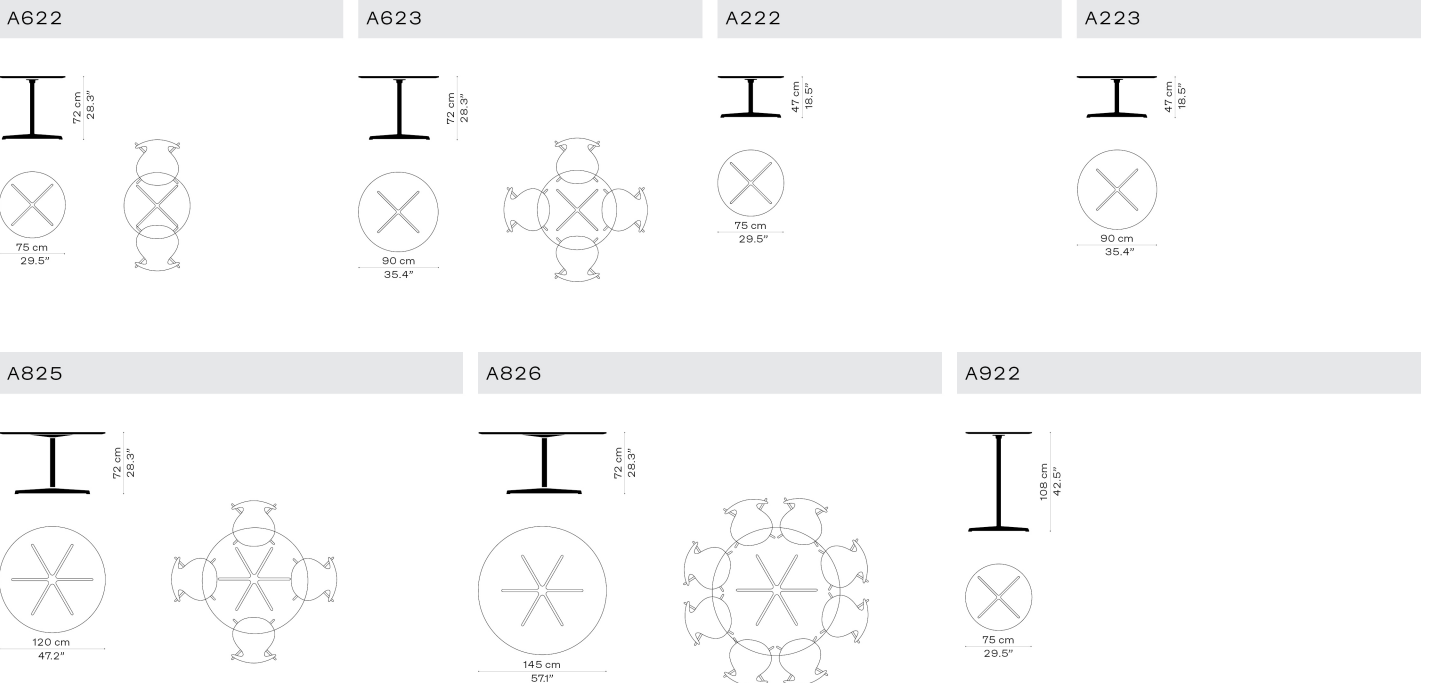



RECTANGULAR
PIET HEIN/BRUNO MATHSSON/ARNE JACOBSEN 1968

01.2026

The Rectangular tables are available in two sizes and with a tabletop made of either Fenix laminate or clear lacquered walnut veneer. While laminate versions come with an aluminum edge, the walnut veneer versions come with a natural wooden edge. The table's iconic span legs are available either in chromed or powder coated steel.

DINING TABLES (HEIGHT 28.3")

MODEL	DESCRIPTION	FENIX LAMINATE	CLEAR LACQUERED WALNUT	H/L/W
B637	Table, span legs, detachable	3,099	4,599	28.3/55.1/31.5
B638	Table, span legs, detachable	3,299	4,599	28.3/63/31.5

OPTIONS

DESCRIPTION	PRICE
Span legs, table height 27.5" (B4) or 29.1" (B8)	149

FENIX LAMINATE COLORS - SEE THE SURFACE SELECTION
 WHITE, GREY, BLACK, BROWN OTTAWA, GREY BROMO, GREY EFESO

SPAN LEGS COLORS
 SILVER GREY, WARM GRAPHITE, BROWN BRONZE, BLACK, WHITE, CHROME

B637

80 X 140 CM | 112 CM |

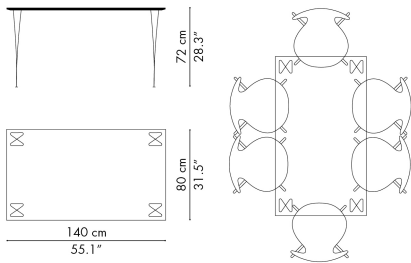

B638

80 X 160 CM | 121 CM |

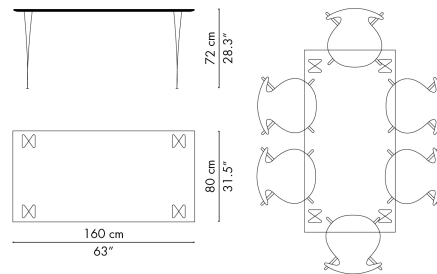



EGG™ TABLE
ARNE JACOBSEN 1952

01.2026

The Egg™ Table is crafted with an FSC-certified clear lacquered walnut veneer tabletop. Resting on three chromed steel legs, the elliptical design is equally purposeful as a kitchen or dining table in smaller spaces as it is in a home office. It fits seamlessly into any setting.

MODEL	DESCRIPTION	CLEAR LACQUERED WALNUT	H/L/W
3603	Table, 3 legs, chromed tubular steel	3,299	29.1/45.3/31.5

3603 H72

3603 H74

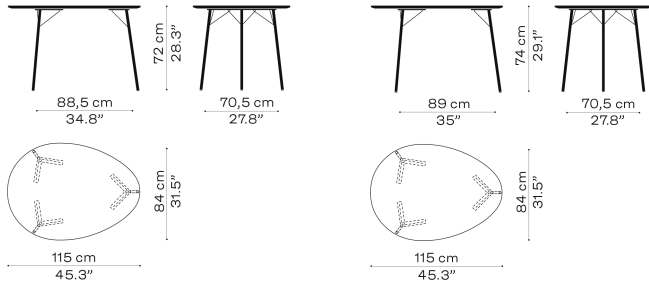



FH3605™
ARNE JACOBSEN 1955

01.2026

The FH3605™ table or "Writing Desk" is a rectangular table available in either black colored ash or clear lacquered walnut veneer. The base consists of four legs made of chromed or black powder coated steel with a solid wood detail matching the tabletop. FH3605™ is available with a document drawer in solid wood in walnut or black colored ash (195). The drawer can be installed in either left or right side.

MODEL	DESCRIPTION	BLACK COLOURED ASH	CLEAR LACQUERED WALNUT	H/L/W
3605DD	Desk with drawer, veneer table top, chromed or powder coated steel, table height 28.4" or 29.1"	4,599	4,999	28.4/59.8/31.5
3605DE	Desk, veneer table top, chromed or powder coated steel, table height 28.4" or 29.1"	3,699	4,199	28.4/59.8/31.5
3605DR	Drawer, solid wood	819	929	3.1/20.5/11.8

FH3605DD FH3605DE FH3605DR

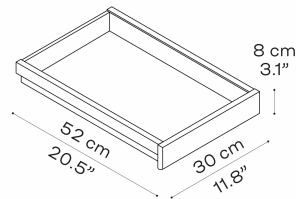
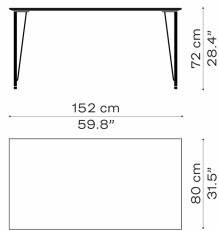
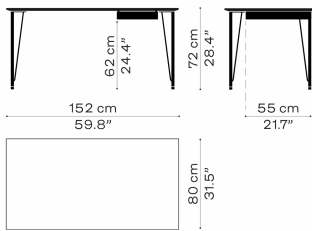



The Essay™ table comes in three sizes and is made of solid oak which is treated with either natural or white pigmented oil. The Essay™ extension leaf comes in two widths and is available in black Fenix laminate.

MODEL	DESCRIPTION	NATURAL OAK	WHITE PIGMENTED OAK	H/L/W
CM21	Table, solid oak	6,899	6,899	28.3/85.8/37.4
CM27	Table, solid oak	9,199	9,199	28.3/107.1/39.4
CM31	Table, solid oak	11,499	11,499	28.3/124.8/39.4

EXTENSION LEAF		BLACK FENIX LAMINATE	L/W
MODEL	DESCRIPTION		
CM95	Extension leaf, black laminate tabletop	1,049	18.9/37.4
CM100	Extension leaf, black laminate tabletop	1,049	18.9/39.4

CM21 **CM21 + 2/CM95**

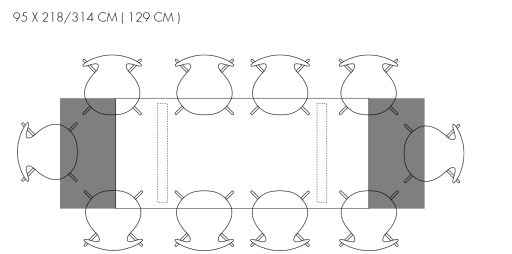
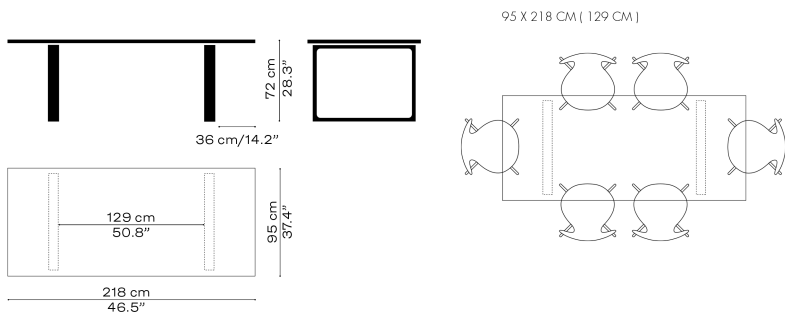

CM27 **CM27 + 2/CM100**

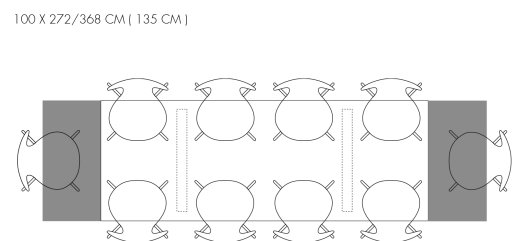
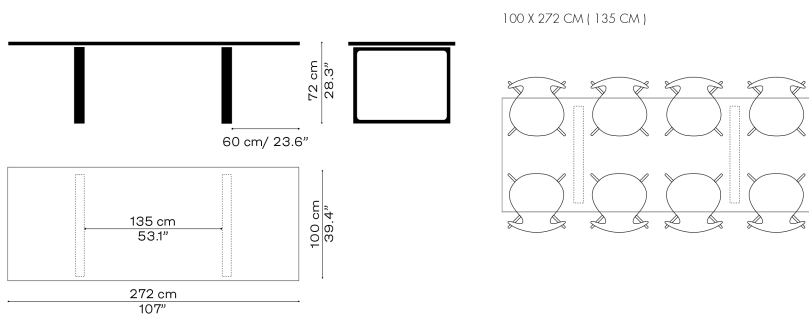



CM31

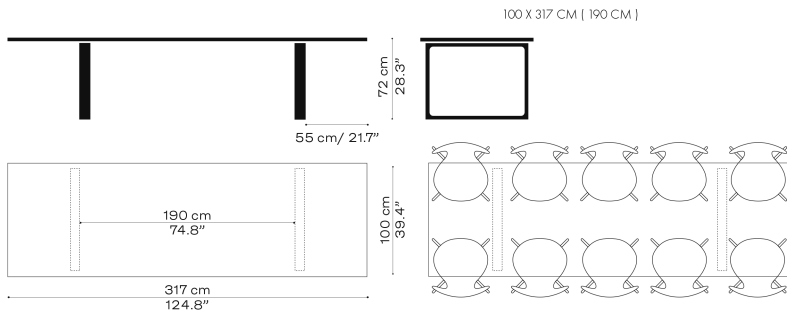

CM31 + 2/CM100

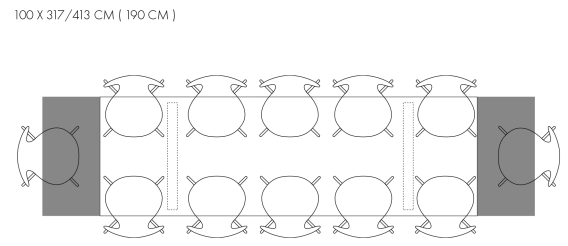

CM95

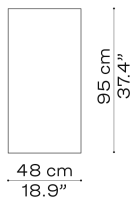

CM100

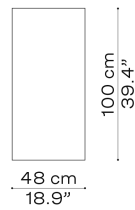



The Analog™ table series consists of a dining table, coffee table and side table. The tabletops share a distinctive shape and are crafted in both laminate and veneer versions. The legs are solid wood and are attached to the tabletop with an elegant 'trumpet'.

MODEL	DESCRIPTION	COLOURED VENEER	CLEAR LACQUERED SOLID WOOD (PFLEIDERER)	LAMINATE	CLEAR LACQUERED VENEER	H/L/W
JH43	Table, laminate or veneer top, legs in solid wood	-	-	2,599	2,999	28.3/51.1/41.3
JH63	Table, laminate or veneer top, legs in solid wood	-	-	2,999	3,799	28.3/72.8/41.3
JH83	Table, laminate or veneer top, legs in solid wood	-	-	3,699	4,799	28.3/96.5/41.3
JH93	Table, laminate top, legs in solid wood	-	-	2,349	-	28.3/43.3/43.3
JH43A	Side table, top and legs in solid oak wood		1,399			16.9/18.7/24.4
JH63A	Coffee table, veneer top, legs in solid wood (only available in walnut)	1,999	-		2,299	14.2/31.1/40.7

TABLE WITH TABLETOP IN WHITE LAMINATE OR CLEAR LACQUERED OAK VENEER IS AVAILABLE WITH LEGS IN CLEAR LACQUERED OAK AND WHITE TRUMPETS.
TABLE WITH TABLETOP IN CLEAR LACQUERED WALNUT VENEER IS AVAILABLE WITH LEGS IN BLACK COLORED OAK OR CLEAR LACQUERED WALNUT, BOTH WITH BLACK TRUMPETS.

JH43 **JH63**

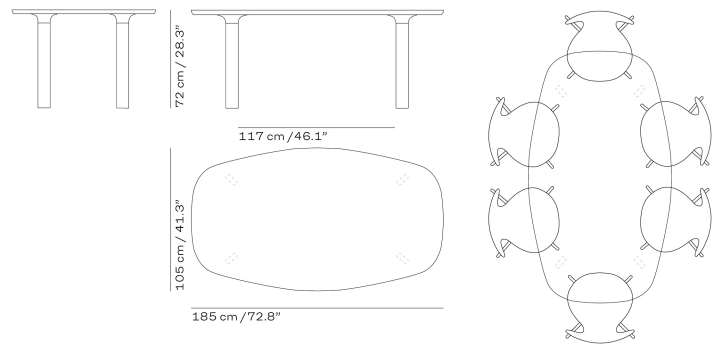
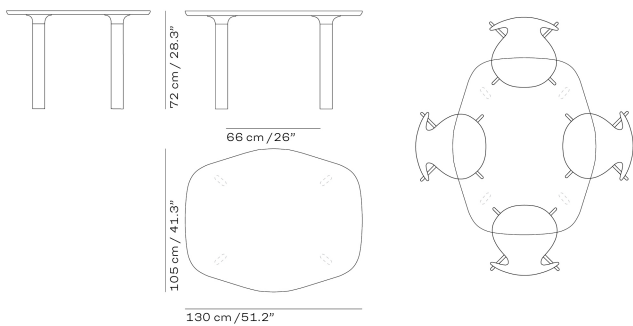

JH83 **JH93**

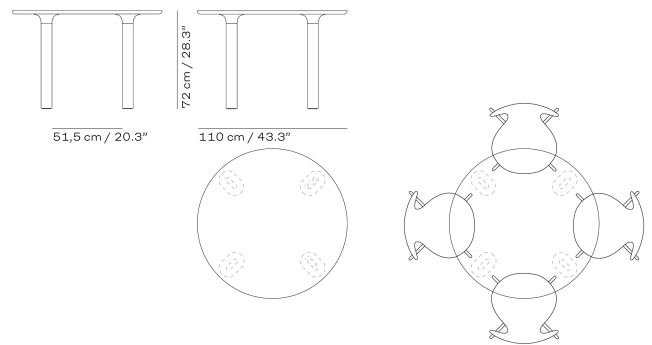
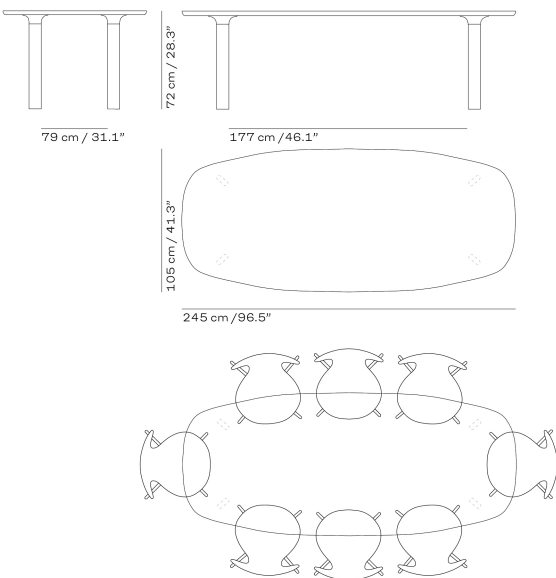

JH43A **JH63A**

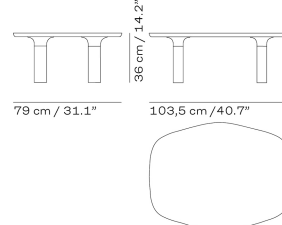
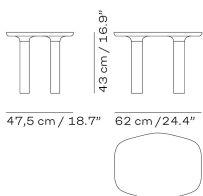



PLURALIS™
KASPER SALTO 2016

01.2026

The Pluralis™ table comes in a wide range of sizes and with five different table tops: Mauve Brown linoleum, Lava Grey or white laminate (Polyrey) and clear lacquered oak or walnut veneer. The base is made of die-cast aluminum and comes with a polished or powder coated finish. The base is mounted with adjustable glides. Cable management is optionally available.

MODEL	DESCRIPTION	LAMINATE (POLYREY)	LINOLEUM	VENEER: OAK	VENEER: WALNUT
KS430	Table, rectangular, polished or powder coated aluminium, 31.5" x 63"	2,799	3,399	4,399	4,499
KS431	Table, rectangular, polished or powder coated aluminium, 31.5" x 70.9"	3,299	3,799	4,799	4,899
KS432	Table, rectangular, polished or powder coated aluminium, 39.4" x 78.7"	3,499	4,199	5,399	5,499
KS433	Table, rectangular, polished or powder coated aluminium, 39.4" x 86.6"	3,899	4,499	5,499	5,599
KS434	Table, rectangular, polished or powder coated aluminium, 39.4" x 94.5"	4,199	5,099	6,599	6,699
KS434A	Table, rectangular, polished or powder coated aluminium, 39.4" x 114.2 "	4,999	5,999	7,799	7,999
KS435	Table, rectangular, polished or powder coated aluminium, 47.2" x 126"	5,599	6,799	8,799	8,999
KS436	Table, rectangular, polished or powder coated aluminium, 47.2" x 189"	8,399	9,999	12,999	13,499
KS437	Table, wall-mounted tapered, polished or powder coated aluminium, 31.5/47.2" cm x 47.2"	6,399	6,899	7,899	7,999
KS438	Table, tapered, polished or powder coated aluminium, 31.5"/47.2" x 94.5"	6,899	7,399	8,299	8,399
KS439	Table, double tapered, polished or powder coated aluminium, 31.5"/47.2" x 189"	10,499	10,999	11,999	11,999

LAMINATE COLORS:
WHITE, LAVA GREY

LINOLEUM COLORS:
MAUVE BROWN

CLEAR LACQUERED VENEER:
Oak, Walnut

BASE COLORS:
BROWN BRONZE, BLACK, POLISHED ALUMINUM

CABLE MANAGEMENT

DESCRIPTION	PRICE
Power Frame, including 4-module power strip, 28,4 cm x 7,3 cm, stainless steel, 3 m power infeed cable	799
Top Frame including 4-module power strip, 30,3 cm x 9,4 cm, with lid matching the tabletop, 3 m power infeed cable	2,399
Rectangular cable well, L 12.8" x B 5.1", incl. cut out, aluminum (1 pcs)	369
Round cable well, Ø 3.5", incl. cut out, aluminum (1 pcs)	369
Cable tray, 25.6", black powder coated steel	319
Cable hose, 30.7"-49.2", black or silver	319
Cut out for customer's own electrification solution is available, with pricing determined on a case-by-case basis.	



KS430

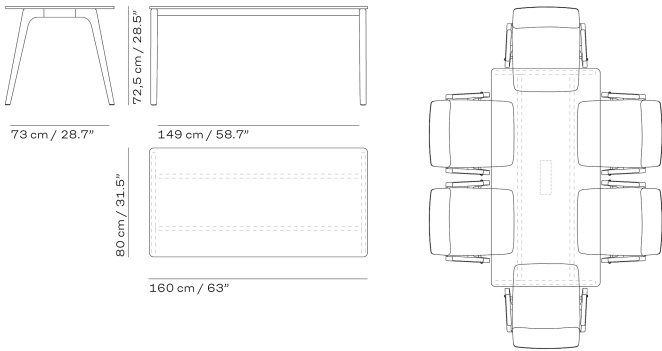

KS431

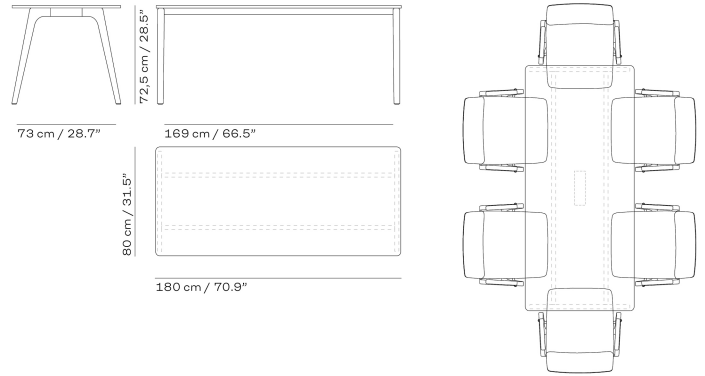

KS432

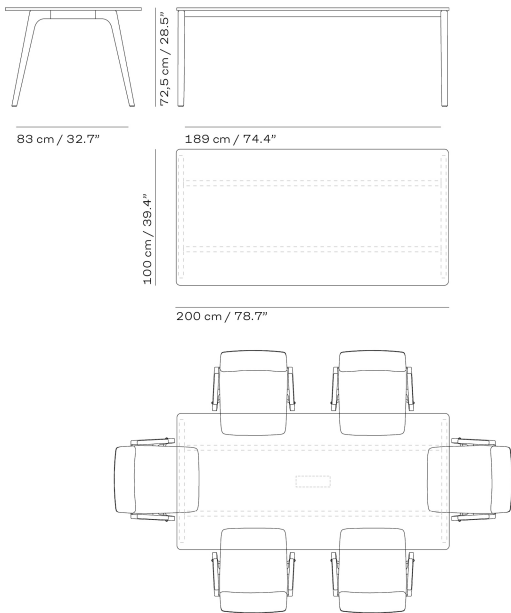

KS433

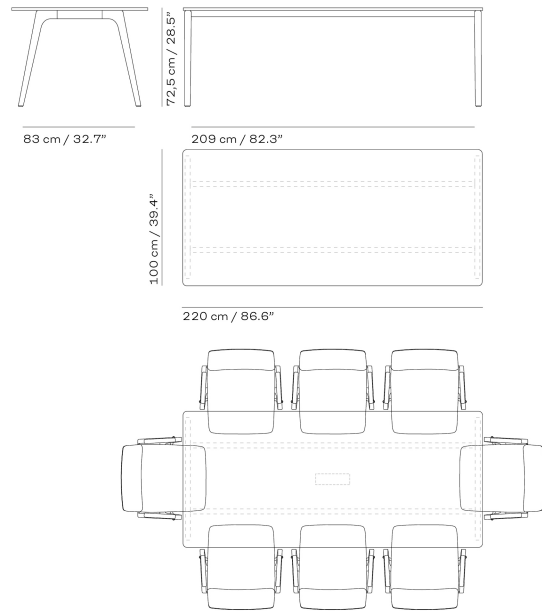

KS434

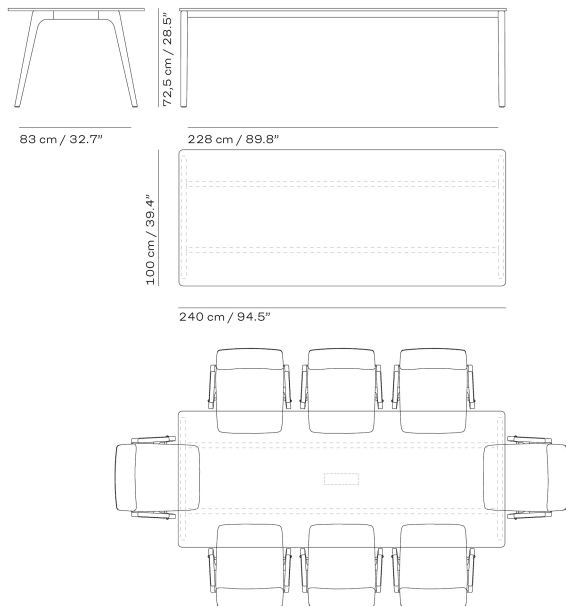

KS434A

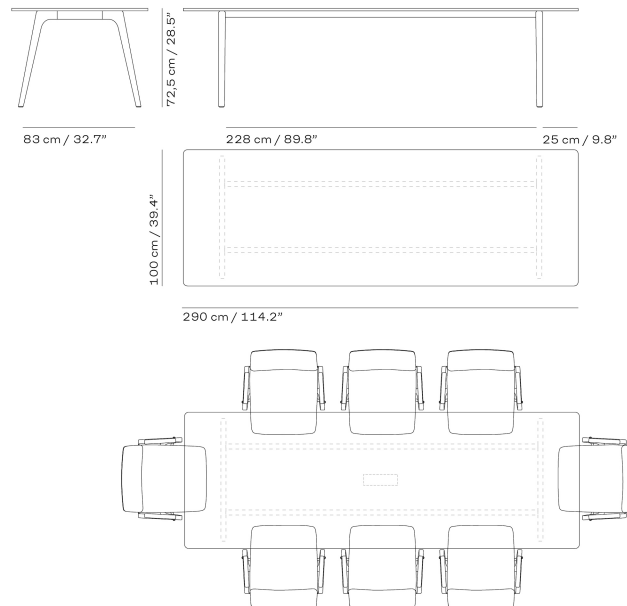



KS435

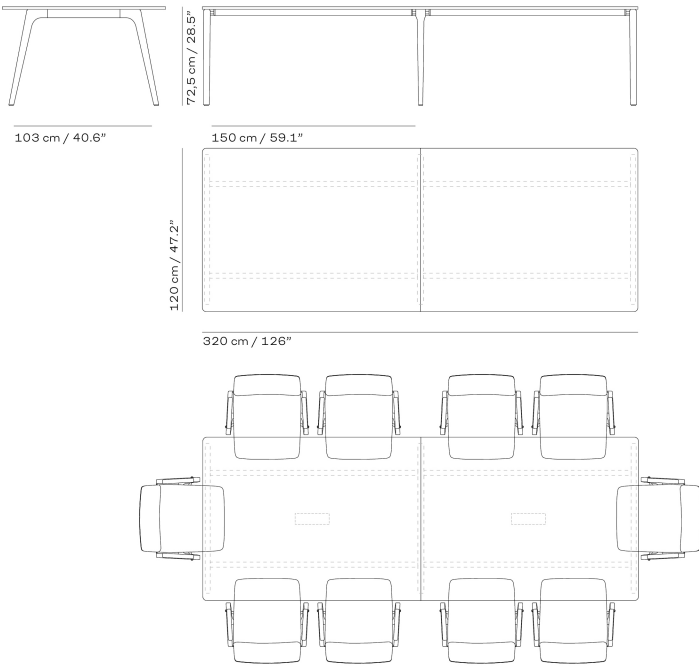

KS436

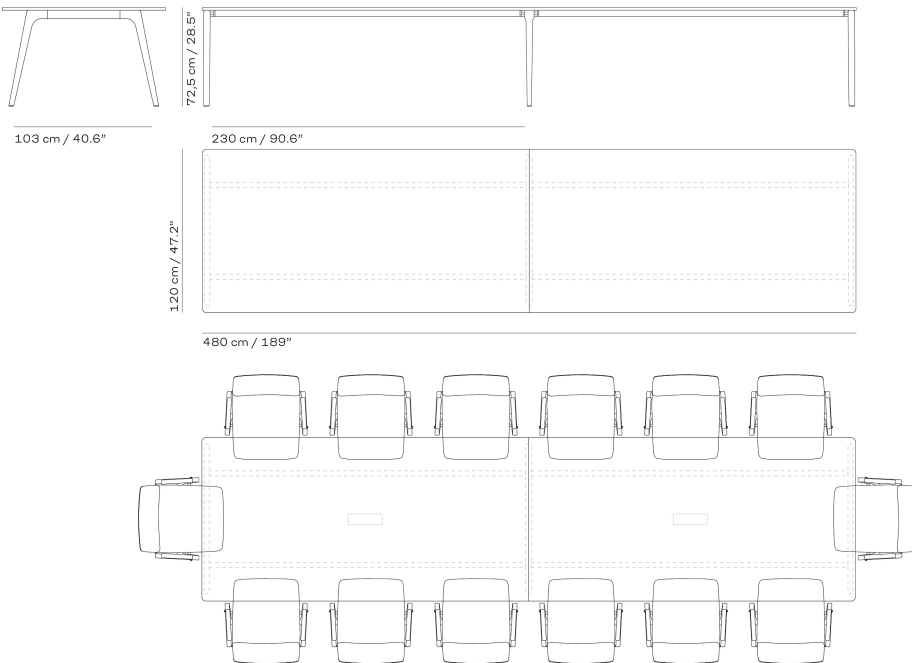



KS437

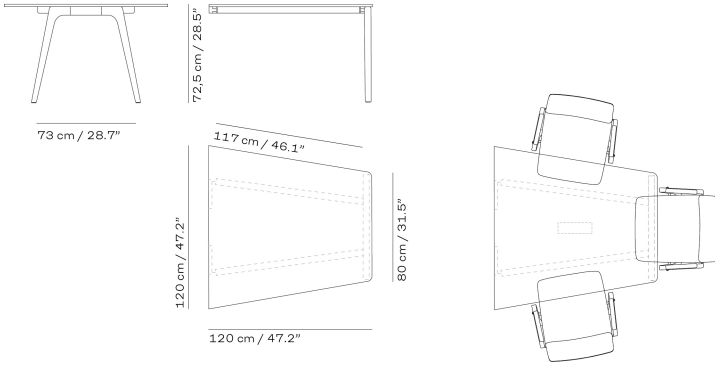

KS438

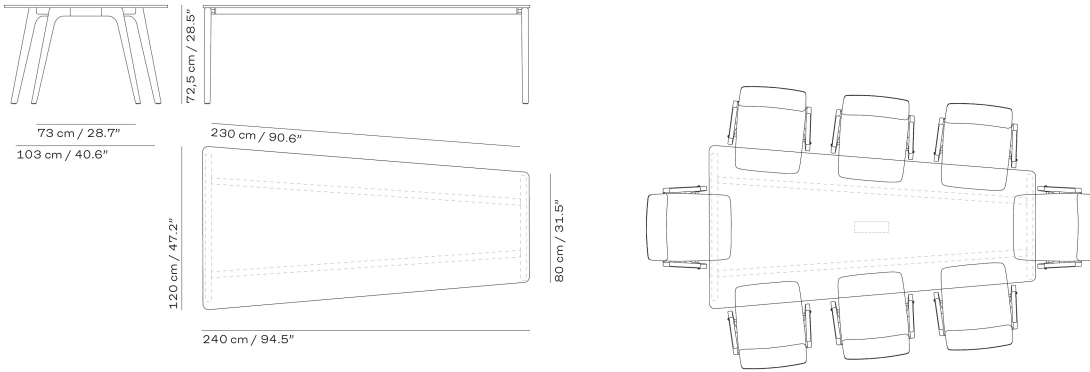

KS439

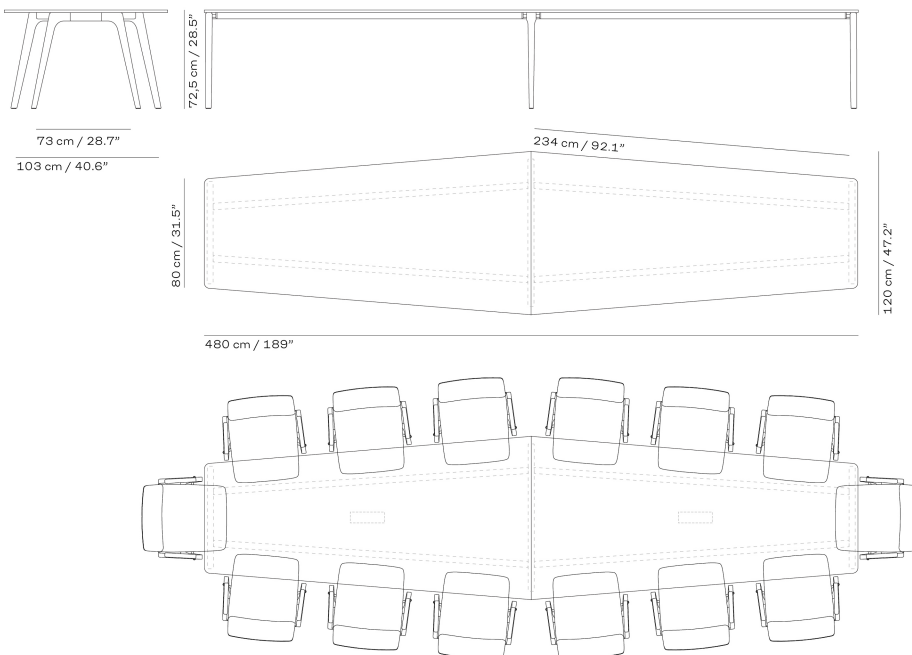



AFTER MICHAEL ANASTASSIADES 2025

01.2026

The After series by Michael Anastassiades reinterprets classic design archetypes with sculptural clarity and generous proportions. Comprising a chair in clear ash or burgundy finish, and a table in ash with an optional red marble tabletop, the series brings quiet strength and refined presence to dining and lounge settings. An optional fitted cushion is available for the chair.

MODEL	DESCRIPTION	OILED ASH	WHITE	MARBLE	H/Ø
		PIGMENTED			
MA400	Table, (Ø:47.2"), tabletop and base in solid wood	5,499	-		28.7/47.2
MA410	Table, (Ø:47.2"), tabletop in red-white honed marble and base in Burgundy coloured solid wood	-	7,699		28.5/47.2

MA400/MA410

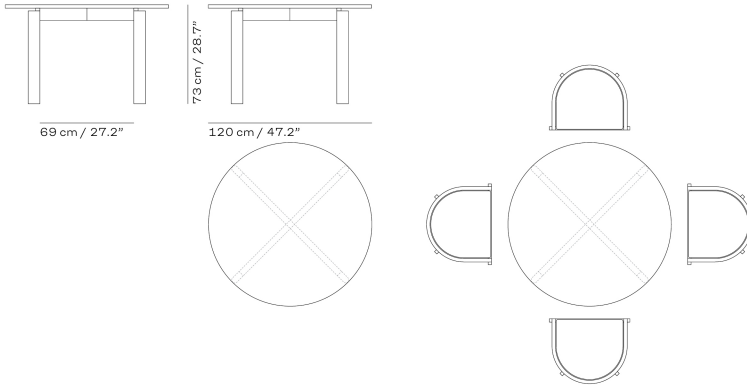



GEORG
CHRIS LILJENBERG HALSTRØM

01.2026

Taking up a minimum of space, the two-legged Georg Console Table fits neatly against the wall. It is a highly functional and beautiful piece suited for an array of uses in almost any room. Use it as a desk, a practical stand in the hall, a vanity table in the bedroom or as a minimalist TV stand in the living room. The Georg Console Table is made of FSC-certified oak.

CONSOLE TABLES

ITEM NO.	DESCRIPTION	PRICE
S1930302	Console table, table height 28.7", oak FSC 100%	1,249

DESKS

ITEM NO.	DESCRIPTION	PRICE
S1930331	Desk wall, table height 28.7", oak FSC 100 %	1,449
1930344	Desk, table height 28.7", oak FSC 100%	
1930344-3	Desk, table height 28.7", oak/oil FSC 100%	

TABLES

ITEM NO.	DESCRIPTION	PRICE
1930506	Georg dining table, table height 28.7", oak/ white oil FSC mix	3,099
1930507	Georg dining table, table height 28.7", oak oil FSC mix	3,099
1930508	Georg dining table, table height 28.7", oak FSC mix	2,599



CONSOLE TABLE

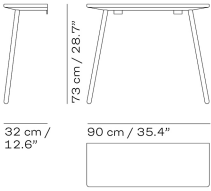

DESK WALL

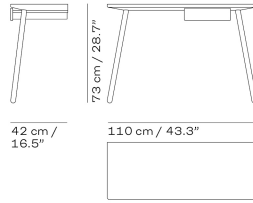

DESK

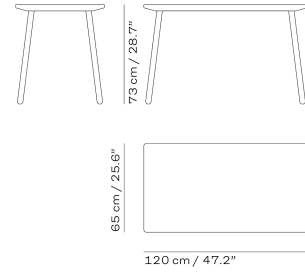

DRAWER

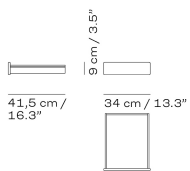

DINING TABLE

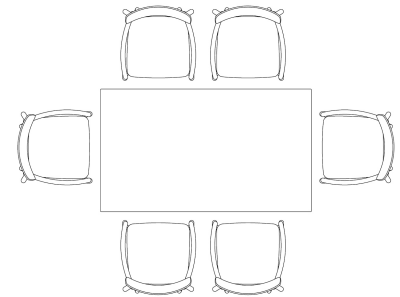
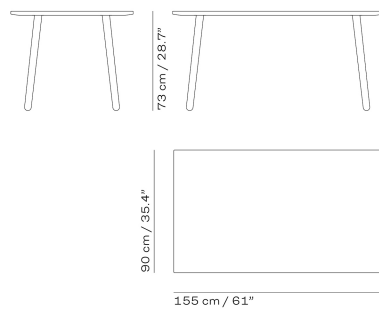



HVEN ANTON BJÖRSING

01.2026

Hven Table is made from solid, FSC-certified oak with a stunning grain pattern and remarkable durability. A soft, minimalist design characterised by round legs and corners. Size Ø110 is perfect for smaller spaces or in the kitchen as the round shape visually takes up less space. Fits up to four people.

ITEM NO.	DESCRIPTION	PRICE
1420009	Table Ø110, table height 28.7", oak FSC 100%	3,499
1420009-2	Table Ø110, table height 28.7", oak/white oil FSC 100%	3,899
1420009-3	Table Ø110, table height 28.7", oak oil FSC 100%	3,899

TABLE Ø110

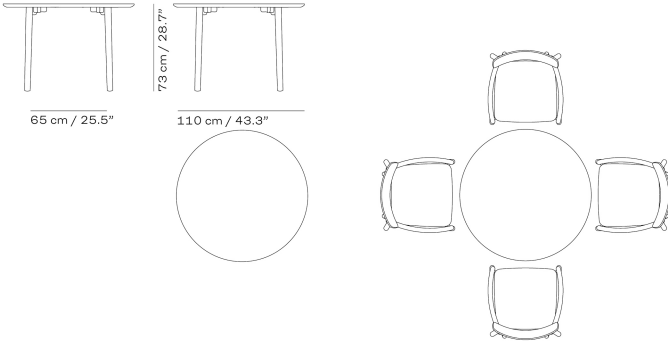

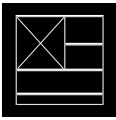

PLANNER™ SHELVING
PAUL MCCOBB 1952/2019

01.2026

The Planner™ Shelving Series comes in three sizes with shelves in clear lacquered oak veneer and a black powder coated steel frame.

MODEL	DESCRIPTION	CLEAR LACQUERED OAK	H/L/W
MC500	Shelving, small, oak veneer, powder coated steel frame	2,099	33.2/47.5/15"
MC510	Shelving, medium, oak veneer, powder coated steel frame	2,599	48.5/47.5/15"
MC520	Shelving, large, oak veneer, powder coated steel frame	3,099	65/47.5/15"

MC500

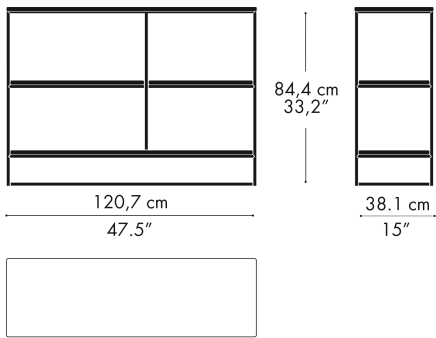

MC510

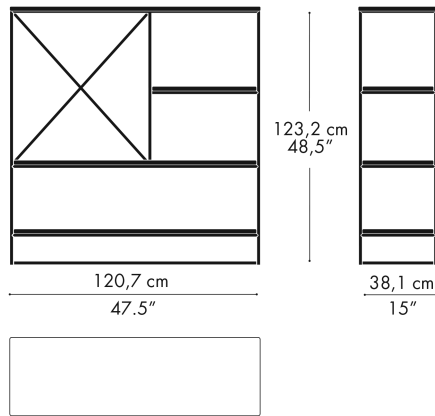

MC520

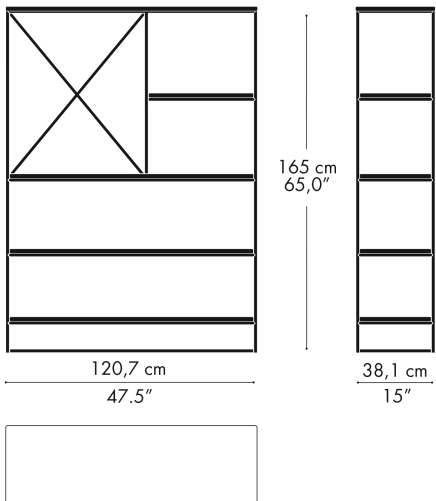

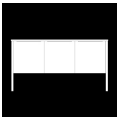

JUT
THOMAS JENKINS

01.2026

The round legs placed at the outer corners and the sleek brass handles give Jut a light and graceful expression. The shelves of the cabinet are adjustable with fittings on the inner side. Jut High Cabinet is suitable in almost any room, adding contemporary Nordic functionality to the practicality of storage. The tabletop comes in either oak or marble – both materials known for their beautifully vivid structures.

ITEM NO.	DESCRIPTION	PRICE
1090102	Jut cabinet, table height 26.8", oak FSC mix	3,499
1090101	Jut cabinet, table height 26.8", black marble/oak FSC mix	4,299
1090104	Jut cabinet, table height 26.8", green marble/oak FSC mix	4,299
1090106	Jut high cabinet, table height 44.8", black marble/ oak FSC mix	4,299
1090107	Jut high cabinet, table height 44.8", green marble/ oak FSC mix	4,299
1090108	Jut high cabinet, table height 44.8", oak FSC mix	3,499

CABINET

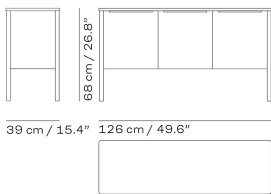

CABINET HIGH

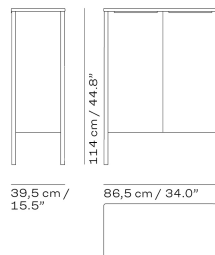



A selection of spare parts for chairs, lounge furniture and tables. Items are sold in colli unless stated otherwise.

CHAIRS

DESCRIPTION	PRICE
Glides for Ant™, Series 7™, Grand Prix™ and Lily™, Black. 1 colli (24 pcs)	4
Glides w/felt for Ant™, Series 7™, Grand Prix™ and Lily™, Black. 1 colli (24 pcs)	4
Glides for Grand Prix™ (4130) wooden base. 1 colli (24 pcs)	4
Glides w/felt for Grand Prix™ (4130), wooden base. 1 colli (24 pcs)	4
Hard castor for soft floors with alu cap for Series 7™, no brake	29
Soft castor for hard floors with alu cap for Series 7™, no brake	29
Hard castor for soft floors with alu cap and tap for Series 7™ produced before 2003, no brake	29
Soft castor for hard floors with alu cap and tap for Series 7™ produced before 2003, no brake	29
Hard castor for soft floors with alu cap for Oxford™, no brake	29
Soft castor for hard floors with alu cap for Oxford, no brake	29
Spacer for Ant™, Series 7™, Grand Prix™, Lily™, High Dot™ & Dot™, Black or Grey rubber. 1 colli (24 pcs)	4
Cover for Ant™, Series 7™, Grand Prix™, Lily™ & Dot™ (4-legs), Black plastic. 1 colli (6 pcs)	24
Cover for Ant™ & High Dot™ (3-legs), Black plastic. 1 colli (6 pcs)	24
Base, seat height 16.9", 18.1" or 18.9", for Ant™, Series 7™ & Grand Prix™, 4 legs, chromed or powder coated steel	349

FERRULE / FERRULE W. FELT

SPACER

COVER



CHAIR BASE

CASTOR (SERIES 7™)

CASTOR (OXFORD™)



LOUNGE & SOFAS

DESCRIPTION	PRICE
Glides for the Egg™, Swan™ and Swan sofa™, molded Black polyamide. 1 colli (4 pcs)	4
Glider with felt for the Egg™, Swan™ and Swan sofa™, molded Black polyamide. 1 colli (4 pcs)	4
Adjustment handle for the Egg™, polished stainless steel	219

GLIDE

GLIDE W. FELT

ADJUSTMENT HANDLE





TABLES

DESCRIPTION	PRICE
Glide for span legs, transparent plastic. 1 colli (4 pcs)	9
Span legs (set of 4 pcs.), table height 27.5" (B4), without mounting plate, chromed or powder coated steel	1,249
Span legs (set of 4 pcs.), table height 28.3" (B6), without mounting plate, chromed or powder coated steel	1,249
Pedestal base 4-star, table height 18" (A2), satin brushed aluminium, satin chromed pedestal	1,349
Pedestal base 4-star, table height 28.3" (A6), satin brushed aluminium, satin chromed pedestal	1,349
Pedestal base, 4-star, table height 42.5" (A9), satin brushed aluminium, satin chromed pedestal	1,349
Pedestal base, 6-star, table height 28.3" (A8), satin brushed aluminium, satin chromed pedestal	2,799
Laminate cleaner for White laminate. 1 colli (6 pcs)	179
Cleaning sponges for laminate tabletops. 1 colli (10 pcs)	14
Essay™ oil kit, natural (1 pcs)	119
Essay™ oil kit, White pigmented (1 pcs)	119
Stonewash for marble tables (1 pcs)	59

SPAN LEGS	A2	A6	A8	A9
-----------	----	----	----	----

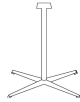

GLIDER SPAN LEGS	LAMINATE CLEANER	ESSAY OIL KIT	STONE WASH	CLEANING SPONGES
------------------	------------------	---------------	------------	------------------



SURFACE SELECTION

- 73 • Textiles
- 76 • Leather
- 79 • Seat cushions
- 80 • Wood
- 82 • Plastic
 - Paper cord
- 83 • Laminate
 - Linoleum
 - Marble
- 84 • Metal

SURFACE SELECTION

TEXTILES

Please note that not all textiles are suitable on all the furniture. On each individual model the standard textile options are listed. Some textiles are only available in a selection of colours.

CUSTOMER'S OWN MATERIAL (COM)

Customers can supply their own textile. Textile requirements, based on standard textiles (plain and unpatterned) 140 cm/1.53 yd wide, can be given on inquiry. We reserve the right to reject textiles that we find unsuitable for upholstery.

CHRISTIANSHAVN™

MATERIALS: 85% WOOL, 15% POLYAMID
DURABILITY: 200.000 MARTINDALE
COLOURS: 26

CATEGORY 1

BELFAST (VELVET)
MATERIALS: 100% COTTON
DURABILITY: 50.000 MARTINDALE
COLOURS: 10

CANVAS
MATERIALS: 90% NEW WOOL (WORSTED), 10% NYLON
DURABILITY: 100.000 MARTINDALE
COLOURS: ALL

CAPTURE
MATERIALS: 85% WOOL, 15% POLYAMID
DURABILITY: 200.000 MARTINDALE
COLOURS: ALL

FAME
MATERIALS: 95% WOOL, 5% POLYAMID
DURABILITY: 200.000 MARTINDALE
COLOURS: ALL

RE-WOOL
MATERIALS: 45% RECYCLED WOOL, 45% NEW WOOL (WORSTED), 10% NYLON
DURABILITY: 100.000 MARTINDALE
COLOURS: ALL

REMIK
MATERIALS: 90% NEW WOOL (WORSTED), 10% NYLON
DURABILITY: 100.000 MARTINDALE
COLOURS: ALL

TECHNICOLOUR
MATERIALS: 100% BRITISH WOOL (WORSTED)
DURABILITY: 80.000 MARTINDALE
COLOURS: ALL

TONUS
MATERIALS: 90% NEW WOOL, 10% HELANCA
DURABILITY: 100.000 MARTINDALE
COLOURS: ALL

CATEGORY 2

ACCA
MATERIALS: 35% VISCOSE, 33% RECYCLED COTTON, 25% RECYCLED POLYESTER, 7% RECYCLED POLYACRYLIC
DURABILITY: 50.000 MARTINDALE
COLOURS: ALL

CIFRADO
MATERIALS: 42% RECYCLED POLYESTER, 27% VISCOSE 24% RECYCLED COTTON, 7% LINEN
DURABILITY: 30.000 MARTINDALE
COLOURS: ALL

CLAY
MATERIALS: 76% LINEN, 21% COTTON, 3% POLYESTER
DURABILITY: 45.000 MARTINDALE
COLOURS: ALL

FIORD
MATERIALS: 92% NEW WOOL (WORSTED), 8% NYLON
DURABILITY: 60.000 MARTINDALE
COLOURS: ALL

HALLINGDAL
MATERIALS: 70% NEW WOOL, 30% VISCOSE
DURABILITY: 100.000 MARTINDALE
COLOURS: ALL

KARAKORUM
MATERIALS: 42% WOOL, 33% VISCOSE, 24% COTTON, 1% POLYAMID
DURABILITY: 40.000 MARTINDALE
COLOURS: ALL

MOSS
MATERIALS: 52% COTTON, 22% VISCOSE, 14% POLYACRYLIC, 6% LINEN, 3% POLYESTER, 3% NYLON
DURABILITY: 50.000 MARTINDALE
COLOURS: ALL

STEELCUT
MATERIALS: 90% NEW WOOL (WORSTED), 10% NYLON
DURABILITY: 100.000 MARTINDALE
COLOURS: ALL

STEELCUT TRIO
MATERIALS: 90% NEW WOOL (WORSTED), 10% NYLON
DURABILITY: 100.000 MARTINDALE
COLOURS: ALL

SUNNIVA
MATERIALS: 58% NEW WOOL, 25% VISCOSE, 8% LINEN, 5% NYLON, 4% POLYESTER
DURABILITY: 50.000 MARTINDALE
COLOURS: ALL

VANIR
MATERIALS: 92% NEW WOOL (WORSTED), 8% NYLON
DURABILITY: 100.000 MARTINDALE
COLOURS: ALL

VIDAR
MATERIALS: 94% NEW WOOL, 6% NYLON
DURABILITY: 100.000 MARTINDALE
COLOURS: ALL

CATEGORY 3

FUSE
MATERIALS: 65% WOOL (WORSTED), 23% COTTON, 8% VISCOSE, 4% NYLON
DURABILITY: 100.000 MARTINDALE
COLOURS: ALL

MAMMUTH
MATERIALS: 35% ACRYLIC, 19% LINEN, 19% WOOL, 16% VIRGIN WOOL, 6% POLYESTER, 4% POLYAMID, 1% COTTON
DURABILITY: 80.000 MARTINDALE
COLOURS: ALL

VOULEZ-VOUS
MATERIALS: 70% RECYCLED COTTON, 20% POLYESTER, 10% OTHER FIBERS
DURABILITY: 20.000 MARTINDALE
COLOURS: ALL

SEAT CUSHIONS

JUST
MATERIALS: 98% POST-CONSUMER RECYCLED POLYESTER / 2% POLYESTER
DURABILITY: 70.000 MARTINDALE

SALSA
MATERIALS: 100% POLYESTER
DURABILITY: 200.000 MARTINDALE

SURFACE SELECTION

TEXTILES

	ACCA	BELFAST	CANVAS	CAPTURE	CHRISTIANSHAVN	CIFRADO	CLAY	FAME	FIORD	FUSE	HALLINGDAL	KARAKORUM	MAMMUTH	MOSS	REMIX	RE-WOOL	STEELCUT	STEELCUT TRIO	SUNNIVA	TECHNICOLOUR	TONUS	VANIR	VIDAR	VOULEZ-VOUS
ALPHABET™ SOFA SERIES	●		●	●	●	●	●	●	●	●	●	●	●	●	●	●	●	●	●	●	●	●	●	●
ANT™ (Front)	●	●	●	●	●	●	●	●	●	●	●	●	●	●	●	●	●	●	●	●	●	●	●	●
DROP™	●		●	●	●	●	●	●	●	●	●	●	●	●	●	●	●	●	●	●	●	●	●	●
EGG™	●		●	●	●	●	●	●	●	●	●	●	●	●	●	●	●	●	●	●	●	●	●	●
FRED™	●		●	●	●	●	●	●	●	●	●	●	●	●	●	●	●	●	●	●	●	●	●	●
FRI™ (Shell)	●		●	●	●	●	●	●	●	●	●	●	●	●	●	●	●	●	●	●	●	●	●	●
FRI™ (Cushions)	●		●	●	●	●	●	●	●	●	●	●	●	●	●	●	●	●	●	●	●	●	●	●
FRI™ (Footstool)	●		●	●	●	●	●	●	●	●	●	●	●	●	●	●	●	●	●	●	●	●	●	●
FRI™ SOFA	●		●	●	●	●	●	●	●	●	●	●	●	●	●	●	●	●	●	●	●	●	●	●
GRAND PRIX™	●	●	●	●	●	●	●	●	●	●	●	●	●	●	●	●	●	●	●	●	●	●	●	●
LET™	●	●	●	●	●	●	●	●	●	●	●	●	●	●	●	●	●	●	●	●	●	●	●	●
LILY™	●		●	●	●	●	●	●	●	●	●	●	●	●	●	●	●	●	●	●	●	●	●	●
LITTLE GIRAFFE™	●		●	●	●	●	●	●	●	●	●	●	●	●	●	●	●	●	●	●	●	●	●	●
LITTLE GIRAFFE™ (Removable cover)	●		●	●	●	●	●	●	●	●	●	●	●	●	●	●	●	●	●	●	●	●	●	●
LISSONI SOFA™	●		●	●	●	●	●	●	●	●	●	●	●	●	●	●	●	●	●	●	●	●	●	●
MONOLIT™	●		●	●	●	●	●	●	●	●	●	●	●	●	●	●	●	●	●	●	●	●	●	●
OXFORD™	●		●	●	●	●	●	●	●	●	●	●	●	●	●	●	●	●	●	●	●	●	●	●
PLENUM™	●		●	●	●	●	●	●	●	●	●	●	●	●	●	●	●	●	●	●	●	●	●	●
POT™	●		●	●	●	●	●	●	●	●	●	●	●	●	●	●	●	●	●	●	●	●	●	●
RO™ (Shell)	●		●	●	●	●	●	●	●	●	●	●	●	●	●	●	●	●	●	●	●	●	●	●
RO™ (Cushions)	●		●	●	●	●	●	●	●	●	●	●	●	●	●	●	●	●	●	●	●	●	●	●
RO™ (Footstool)	●		●	●	●	●	●	●	●	●	●	●	●	●	●	●	●	●	●	●	●	●	●	●
RO™ SOFA (Shell)	●		●	●	●	●	●	●	●	●	●	●	●	●	●	●	●	●	●	●	●	●	●	●
RO™ SOFA (Cushions)	●		●	●	●	●	●	●	●	●	●	●	●	●	●	●	●	●	●	●	●	●	●	●
SERIES 7™	●	●	●	●	●	●	●	●	●	●	●	●	●	●	●	●	●	●	●	●	●	●	●	●
SERIES 3300™	●		●	●	●	●	●	●	●	●	●	●	●	●	●	●	●	●	●	●	●	●	●	●
SWAN™	●		●	●	●	●	●	●	●	●	●	●	●	●	●	●	●	●	●	●	●	●	●	●
SWAN SOFA™	●		●	●	●	●	●	●	●	●	●	●	●	●	●	●	●	●	●	●	●	●	●	●
VIA57™	●		●	●	●	●	●	●	●	●	●	●	●	●	●	●	●	●	●	●	●	●	●	●
VICO DUO™	●	●	●	●	●	●	●	●	●	●	●	●	●	●	●	●	●	●	●	●	●	●	●	●

SURFACE SELECTION

Colours and materials may vary from the images shown.
Actual colour, gloss level and structure may vary.

SELECTED TEXTILE COLOURS

BELFAST (VELVET)



FOREST GREEN
770660

Grand Prix™
Let™
Series 7™
Vico Duo™

MISTY ROSE
770593

Grand Prix™
Let™
Series 7™
Vico Duo™

NIGHT BLACK
772150

Grand Prix™
Let™
Series 7™
Vico Duo™

DARK PLUM
774232

Grand Prix™
Let™
Series 7™
Vico Duo™

SEAL GREY
775139

Grand Prix™
Let™
Series 7™
Vico Duo™

SOFT OCHRE
774926

Grand Prix™
Let™
Series 7™
Vico Duo™

GREY BROWN
771772

Grand Prix™
Let™
Series 7™
Vico Duo™



AUTUMN RED
772255

Grand Prix™
Let™
Series 7™
Vico Duo™

GREY BLUE
772143

Grand Prix™
Let™
Series 7™
Vico Duo™

MIDNIGHT BLUE
772062

Grand Prix™
Let™
Series 7™
Vico Duo™

CANVAS



WHITE

Director's Chair

SURFACE SELECTION

LEATHER

Please note that leather is a natural material with natural variation in colour and surface structure. The presence of scars and marks from bites etc. on the leather may occur and are characteristics of genuine leather.

CUSTOMER'S OWN LEATHER (COL)

Customers can supply their own leather. Prices excluding leather as well as leather requirements can be given on inquiry. Please note that only very few types of leather/qualities are suitable. Fritz Hansen retains the right to reject the qualities we find unsuitable.

SPECIAL LEATHER COLOURS

On inquiry and at a surcharge, special leather colours may be available for the models available with leather upholstery.

	AURA	ESSENTIAL	GRACE	HAZE	NATURAL	SOFT
ANT™ (Front)		●	●	●	●	●
CHINA CHAIR™	●		●		●	
DROP™	●	●	●	●	●	
EGG™	●	●	●	●	●	
FRED™	●	●	●	●	●	●
GRAND PRIX™		●	●	●	●	●
LET™	●	●	●	●	●	●
LILY™		●	●	●	●	●
LITTLE GIRAFFE™	●	●	●	●	●	
LISSONI SOFA™		●	●	●	●	●
MONOLIT™					●	
OKSEN™	●	●	●	●	●	
OXFORD™		●	●	●	●	●
POT™	●	●	●	●	●	
SERIES 7™		●	●	●	●	●
SERIES 3300™	●	●	●	●	●	
SWAN™	●	●	●	●	●	
SWAN SOFA™	●	●	●	●	●	
VICO DUO™		●	●	●	●	●

SURFACE SELECTION

Colours and materials may vary from the images shown.
Actual colour, gloss level and structure may vary.

LEATHER

AURA



BLACK

BLACK BROWN

COGNAC

WALNUT

BEIGE

China Chair™
Drop™
Egg™
Fred™
Little Giraffe™
Oksen™
Pot™
Series 3300™
Swan™
Swan Sofa™

CATEGORY: 3
Chrome-tanned, top-coated, strong
full-grain and durable surface.

Thickness 1.4-1.6 mm.

ESSENTIAL

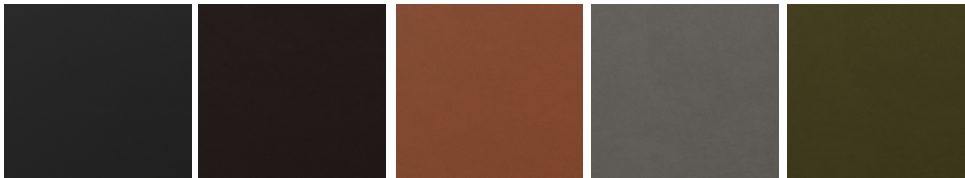

BLACK

DARK BROWN

WALNUT

LAVA

MOSS GREEN

Ant™
Drop™
Egg™
Fred™
Grand Prix™
Let™
Lily™
Little Giraffe™
Lissoni Sofa™
Oksen™
Oxford™
Pot™
Series 7™
Series 3300™
Swan™
Swan Sofa™
Vico Duo™

CATEGORY: 3
Chrome-tanned, lightly polished,
top-coated and grain printed durable
surface.

Thickness 1.0-1.2 mm.

GRACE

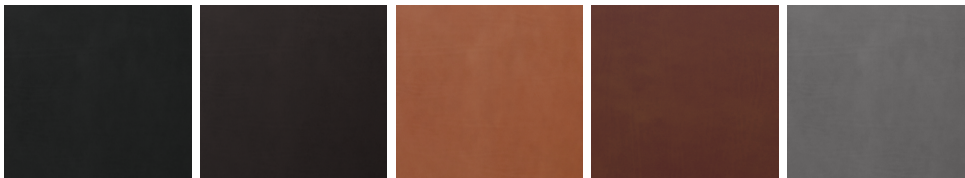

BLACK

DARK BROWN

WALNUT

CHESTNUT

CONCRETE GREY

Ant™
China Chair™
Drop™
Egg™
Grand Prix™
Let™
Lily™
Little Giraffe™
Lissoni Sofa™
Oksen™
Oxford™
Pot™
Series 7™
Series 3300™
Swan™
Swan Sofa™
Vico Duo™

CATEGORY: 5
Vegetable and chrome-tanned, aniline,
full-grain with light structure and light
impregnation. Becomes lighter and
patinated with use, visible natural
markings.

Thickness 1.2-1.4 mm.

SURFACE SELECTION

Colours and materials may vary from the images shown.
Actual colour, gloss level and structure may vary.

LEATHER

HAZE



ANTRACIT

Ant™
Drop™
Egg™
Fred™
Grand Prix™
Let™
Lily™
Little Giraffe™
Lissoni Sofa™
Oksen™
Oxford™
Pot™
Series 7™
Series 3300™
Swan™
Swan Sofa™
Vico Duo™

DARK BROWN

CATEGORY: 4
Chrome-tanned, aniline, top grain leather. Smooth and velvety soft surface with natural markings and colour variations. Over time, the leather will patinate and become smoother and shinier in use.

Thickness 1.0-1.4 mm.

WALNUT

BEIGE

NATURAL



NATURAL

Ant™
China Chair™
Drop™
Egg™
Fred™
Grand Prix™
Let™
Lily™
Little Giraffe™
Lissoni Sofa™
Monolit™
Oksen™
Oxford™
Pot™
Series 7™
Series 3300™
Swan™
Swan Sofa™
Vico Duo™

CATEGORY: 5
Vegetable-tanned, chrome-free, natural leather, no colour or protective finish. Becomes darker and patinated with use, visible natural markings.

Thickness 1.2-1.4 mm.

SOFT



BLACK

Ant™
Fred™
Grand Prix™
Let™
Lily™
Lissoni Sofa™
Oxford™
Series 7™
Vico Duo™

BLACK BROWN

CATEGORY: 4
Chrome-tanned, semi-aniline, full-grain with light structure and surface finish.

Thickness 1.0-1.2 mm.

COGNAC

WALNUT

SURFACE SELECTION

Colours and materials may vary from the images shown.
Actual colour, gloss level and structure may vary.

SEAT CUSHIONS

AFTER (MA100CU)

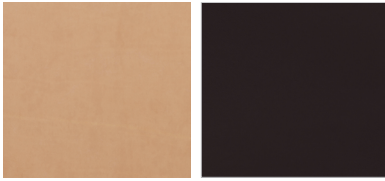

NATURAL
LEATHER
NATURAL

BLACKBERRY
LEATHER
SPECTRUM

DROP™ (3110SC)



GREY
TEXTILE
SALSA 3/36

BLACK
TEXTILE
SALSA 3/39

HVEN

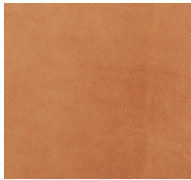

COGNAC
LEATHER
DUNES

N02™ RECYCLE (N02-70)

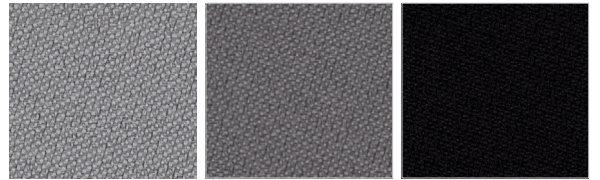

LIGHT GREY
TEXTILE
JUST 60118

DARK GREY
TEXTILE
JUST 60121

BLACK
TEXTILE
JUST 60999

SERIES 7™ (3107SC)

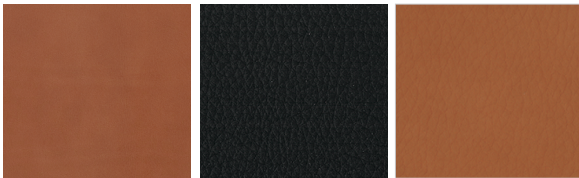

WALNUT
LEATHER
WILD

BLACK
LEATHER
RAW

BROWN
LEATHER
INTENSE

VESTER



COGNAC
LEATHER
DUNES

VICO DUO™ (VM170)

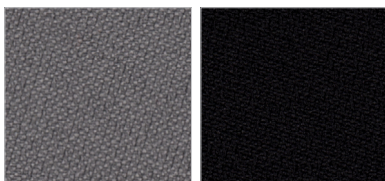

DARK GREY
TEXTILE
JUST 60121

BLACK
TEXTILE
JUST 60999

SURFACE SELECTION

Colours and materials may vary from the images shown.
Actual colour, gloss level and structure may vary.

COLOURED VENEER

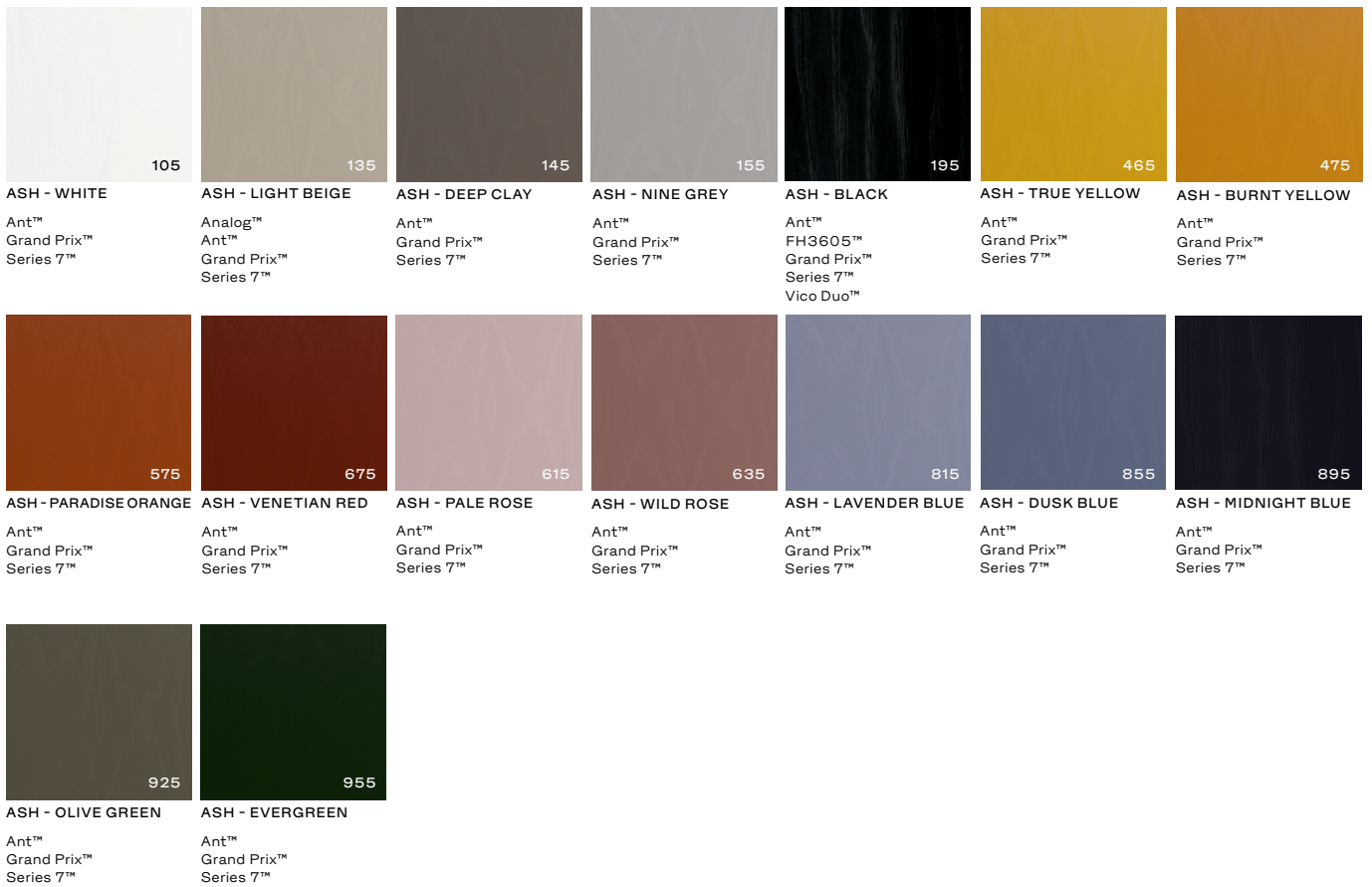

LACQUERED VENEER



SURFACE SELECTION

Colours and materials may vary from the images shown.
Actual colour, gloss level and structure may vary.

CLEAR LACQUERED VENEER



- | | | | | | |
|-------------------|-------------------|-------------------|--|---|---------------------------|
| BEECH | CHERRY | ELM | OAK | WALNUT | OAK - DARK STAINED |
| Ant™
Series 7™ | Ant™
Series 7™ | Ant™
Series 7™ | Analog™
Ant™
Grand Prix™
Planner™ Shelving
Pluralis™
Series 7™
Vico Duo™ | Analog™
Ant™
Circular
Egg™ Table
FH3605™
Grand Prix™
Lily™
Pluralis™
Rectangular
Series 7™
Supercircular™
Superellipse™
Vico Duo™ | Ant™
Series 7™ |

CLEAR LACQUERED SOLID WOOD



- | | | | | |
|------------|---------------|---|-----------------------------|------------------------------------|
| ASH | CHERRY | OAK | OAK - WALNUT STAINED | WALNUT |
| Let™ | China Chair™ | Analog™ (base)
Fred™
Fri™
Fri™ Sofa
Let™
Ro™
Ro™ Sofa
VIA57™ | Fred™ | Analog™ (base)
FH3605™ (drawer) |

OILED SOLID WOOD



- | | |
|--|--|
| OAK - NATURAL | OAK - WHITE PIGMENTED |
| Fred™
Essay™
Georg (Desk)
Georg (Dining table)
Hven
Jut
Vester | Essay™
Georg (Dining table)
Hven |

UNTREATED SOLID WOOD

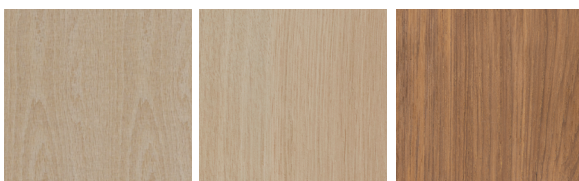

- | | | |
|--------------|---------------|------------------|
| BEECH | OAK | TEAK |
| Carimate™ | Georg
Hven | Director's Chair |

COLOURED SOLID WOOD

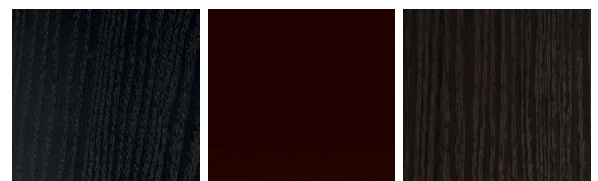

- | | | |
|---|-----------------------|----------------------------------|
| ASH - BLACK | ASH - BURGUNDY | OAK - BLACK |
| Carimate™
China Chair™
FH3605™ (drawer)
Let™ | After | Analog™ (base)
Fred™
Lune™ |

SURFACE SELECTION

Colours and materials may vary from the images shown.
Actual colour, gloss level and structure may vary.

PLASTIC (ABS)

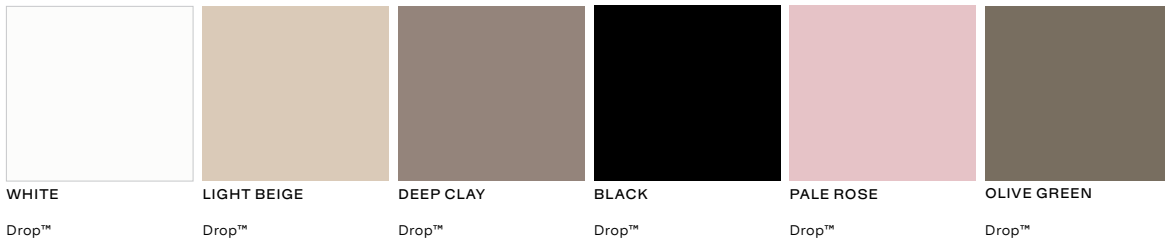

RECYCLED PLASTIC (PP)

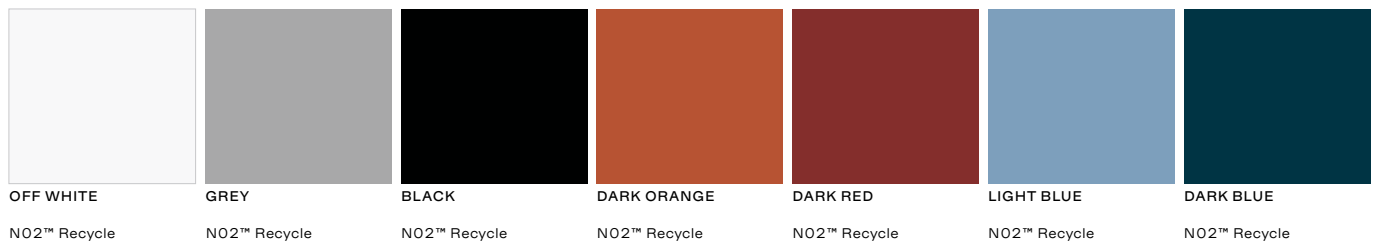

PAPER CORD



NATURAL
Carimate™

SURFACE SELECTION

Colours and materials may vary from the images shown.
Actual colour, gloss level and structure may vary.

LAMINATE (FENIX)

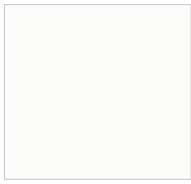

WHITE

Circular
Rectangular
Supercircular™
Superellipse™

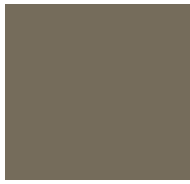

BROWN OTTAWA

Circular
Rectangular
Supercircular™
Superellipse™



GREY

Circular
Rectangular
Supercircular™
Superellipse™



GREY BROMO

Circular
Rectangular
Supercircular™
Superellipse™



GREY EFESO

Circular
Rectangular
Supercircular™
Superellipse™



BLACK

Circular
Essay™ (extension leaf)
Rectangular
Supercircular™
Superellipse™

LAMINATE (POLYREY)



WHITE

Pluralis™



LIGHT GREY

Plenum™



LAVA GREY

Pluralis™

LAMINATE (PFLEIDERER)



WHITE

Analog™

LINOLEUM

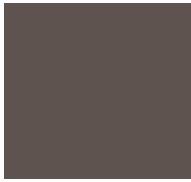

MAUVE BROWN

Pluralis™

HONED MARBLE

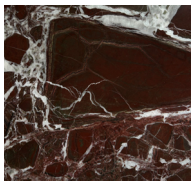

BURGUNDY

After

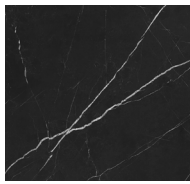

BLACK (NERO)

Jut

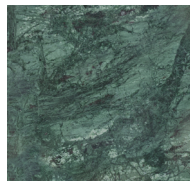

GREEN (VERDE)

Jut

SURFACE SELECTION

Colours and materials may vary from the images shown.
Actual colour, gloss level and structure may vary.

POWDER COATED METAL (STEEL OR ALUMINIUM)



WHITE
Analog™ (trumpet)
Ant™
Drop™
Grand Prix™
Rectangular
Series 7™
Supercircular™
(only span legs)
Superellipse™

BLACK
Analog™ (trumpet)
Ant™
Circular
Drop™
Egg™
FH3605™
Grand Prix™
Let™
Little Giraffe™
NO2™ Recycle
Oksen™
Oxford™
Planner™ Shelving
Plenum™
Pluralis™
Rectangular
Series 7™
Supercircular™
Superellipse™
Swan™
Vico Duo™

SILVER GREY
Ant™
Circular
Egg™
Grand Prix™
Rectangular
Series 7™
Supercircular™
Superellipse™
Swan™

WARM GRAPHITE
Ant™
Drop™
Egg™
Grand Prix™
Rectangular
Series 7™
Superellipse™
Swan™

BROWN BRONZE
Ant™
Circular
Drop™
Egg™
Grand Prix™
Let™
Oxford™
Pluralis™
Pot™
Rectangular
Series 7™
Supercircular™
Superellipse™
Swan™

STEEL



BRUSHED STAINLESS STEEL - MATT

Lissoni Sofa™

CHROMED STEEL - BRIGHT

Ant™
Circular
Drop™
Egg™ Table
FH3605™
Grand Prix™
Let™
Lily™
Little Giraffe™
NO2™ Recycle
Pot™
Rectangular
Series 3300™
Series 7™
Supercircular™
(only span legs)
Superellipse™
Vico Duo™

ALUMINIUM



BRUSHED - MATT

Circular
Egg™
Fri™
Fri™ Sofa
Little Giraffe™
(swivel base)
Oksen™
Oxford™
Ro™
Ro™ Sofa
Swan™
Swan Sofa™
Supercircular™
(only pedestal base)

POLISHED - BRIGHT

Let™ (swivel base)
NO2™ Recycle
(swivel base)
Pluralis™

CHROMED - BRIGHT

Oxford™